

A revolutionary MLCD
Infinitely Expandable MLCD

A revolutionary MLCD
Infinitely Expandable **MLCD**

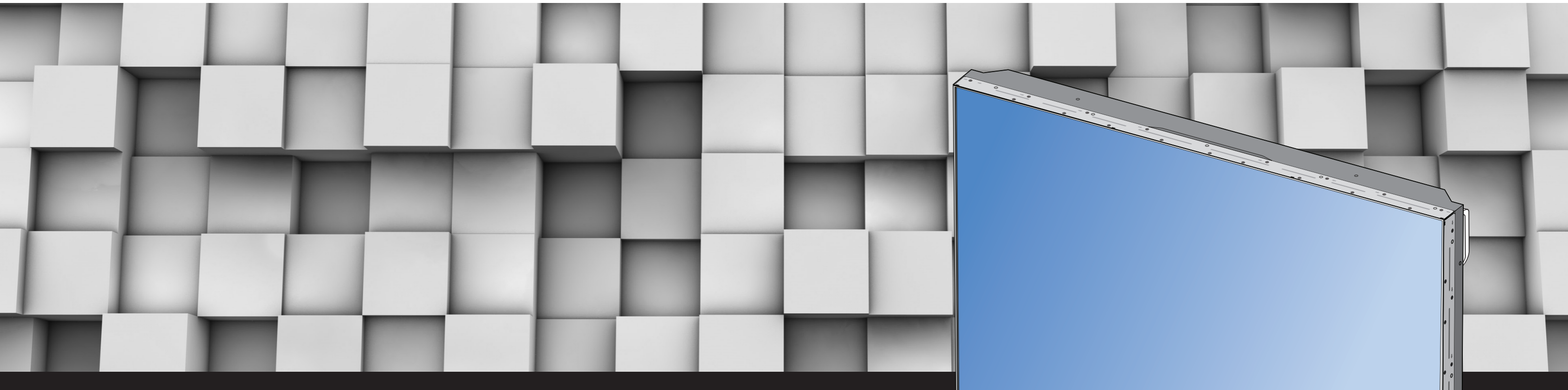

ORION CO.,LTD.
www.oriondisplay.net

Address: 217, Igongdan-ro, Gumi-si, Gyeongsangbuk-do, Korea
Tel : +82-2-6678-8533, Fax: +82-2-6678-8599

OLME-5550S | OLME-5570S

User's Manual

Features

- ▶ Enjoy a wide flat screen with high brightness and high quality.
- ▶ Easy to install and move due to its thin design
- ▶ Enjoy your favorite programs with various split-screen features simultaneously presenting several programs.

Thank you for purchasing our monitor.

This manual describes how to use the product and notes in use.

Please read the manual carefully before using it.

After reading this manual, please retain for future reference.

If you have any questions or a problem occurs, please contact either the company you purchased this product from or an authorized service center.

※ **Displaying static picture for an extended period of time may cause a burn-in effect.**

※ **Burn-in effect and the faults in brightness and picture elements caused by fixed images are not subject to the warranty coverage.**



Warning

If you fail to comply with the regulations for safety and proper use, fire or injury may be caused.



Warning

To prevent electric shock, Do not remove cover.
No user serviceable part inside
Refer servicing to qualified service personnel.

Supplied Accessories

User's manual CD

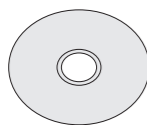

Guide Pin(4pcs)



Power Cable



DVI Cable



RS-232C Cable



Optional Accessories

MAIN FRAME

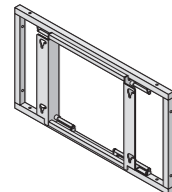

IR Receiver



Battery (AAA X2)

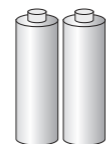

Remote Controller



Notice to users

Class A digital device

It is a device designed for business purpose with a safety certificate for electromagnetic interference, which user should be mindful of.



" Important Safety Instructions"

- 1) Read these instructions.
- 2) Keep these instructions.
- 3) Heed all warnings.
- 4) Follow all instructions.
- 5) Do not use this apparatus near water.
- 6) Clean only with dry cloth.
- 7) Do not block any ventilation openings. Install in accordance with the manufacturer's instructions.
- 8) Do not install near any heat sources such as radiators, heat registers, stoves, or other apparatus (including amplifiers) that produce heat.
- 9) Do not defeat the safety purpose of the polarized or grounding-type plug. A polarized plug has two blades with one wider than the other. A grounding type plug has two blades and a third grounding prong. The wide blade or the third prong are provided for your safety. If the provided plug does not fit into your outlet, consult an electrician for replacement of the obsolete outlet.
- 10) Protect the power cord from being walked on or pinched particularly at plugs, convenience receptacles, and the point where they exit from the apparatus.
- 11) Only use attachments/accessories specified by the manufacturer.
- 12) Use only with the cart, stand, tripod, bracket, or table specified by the manufacturer, or sold with the apparatus. When a cart is used, use caution when moving the cart/apparatus combination to avoid injury from tip-over. 
- 13) Unplug this apparatus during lightning storms or when unused for long periods of time.
- 14) Refer all servicing to qualified service personnel. Servicing is required when the apparatus has been damaged in any way, such as power-supply cord or plug is damaged, liquid has been spilled or objects have fallen into the apparatus, the apparatus has been exposed to rain or moisture, does not operate normally, or has been dropped.
The symbol in figure 21 shall be shown adjacent to the text of item 12 above.

FCC Verified : Class "A"

This device complies with the Part 15 of the FCC Rules. Operation is subject to the following two conditions :

- 1) This device may not cause harmful interference, and
- 2) This device must accept any interference received, including interference that may cause undesired operation.

	
<div style="background-color: black; color: white; padding: 2px; margin-bottom: 5px;">RISK OF ELECTRIC SHOCK</div> <div style="background-color: white; color: black; padding: 2px; margin-bottom: 5px;">DO NOT OPEN</div>	
<p>CAUTION : TO REDUCE THE RISK OF ELECTRIC SHOCK, DO NOT REMOVE COVER (OR BACK). NO USER-SERVICEABLE PARTS INSIDE. REFER SERVICING TO QUALIFIED SERVICE PERSONNEL.</p>	



This symbol is intended to alert the user to the presence of uninsulated "dangerous voltage" within the product's enclosure that may be of sufficient magnitude to constitute a risk of electric shock to persons.



This symbol is intended to alert the user to the presence of important operating and maintenance(servicing) instructions in the literature accompanying the appliance.

NOTICE

1. To disconnect the apparatus from the mains, the plug must be pulled out from the mains socket, therefore the mains plug shall be readily operable
2. WARNING - To Reduce The Risk Of Fire Or Electric Shock, Do Not Expose This Appliance To Rain Or Moisture.
3. Apparatus shall not be exposed to dripping or splashing and no objects filled with liquids, such as vases, shall be placed on the apparatus.
4. Use only a properly grounded plug and receptacle
5. "Warning" CAUTION – These servicing instructions are for use by qualified service personnel only. To reduce the risk of electric shock, do not perform any servicing other than that contained in the operating instructions unless you are qualified to do so.

Contents

※European Union Disposal Information	4
※Cautions for consisting	5
※Clearance for Ventilation	6
※Cleaning and Maintenance	7
※Please keep following instruction for panel protection without exception.	8
※Handle with Caution.	9
※How to carry	10
※Application information	11
※Attention for Installing	12
1. Safety Precautions	14
2. Names	16
3. How to Connect Cables	18
3.1. Connection of Single	18
3.2. Connection of Multiple (for DP in)	20
3.3. Connection of Multiple (for HDMI in)	21
3.4. Connection of Multiple (for DVI in)	22
3.5. Connection of Multiple (for PC in)	23
3.6. Connection of Control Cable	24
4. ID Setting	26
4.1. Sequential Connection	26
4.2. Random Connection	28
5. Setting and operation of MSCS software	32
5.1. Installation	32
5.2. Start MSCS	33
5.3. Communication Configuration	34
5.4. Design Selection	40
5.5. Screen Configuration	41
5.6. Selecting the Command transmission method	42
5.7. Changing the Input source	43
5.8. Displaying the Multi Screen	46
5.9. Control	49
5.10. Help	58
6. Remote Controller	59
6.1. How to use Remote Controller	60
6.2. Configuration	61
7. Before calling for service	105
8. Applicable signals	106
9. Specification	107
10. Regulatory Information	108
11. Dimension	109 ~111

❖ European Union Disposal Information

English

Disposal of old Electrical & Electronic Equipment (Applicable throughout the European Union and other European countries with separate collection programs)

This symbol found on your product or on its packaging, indicates that this product should not be treated as household waste when you wish to dispose of it. Instead, it should be handed over to an applicable collection point for the recycling of electrical and electronic equipment. By ensuring this product is disposed of correctly, you will help prevent potential negative consequences to the environment and human health, which could otherwise be caused by inappropriate disposal of this product. The recycling of materials will help to conserve natural resources.



This symbol is only valid in the European Union. If you wish to discard this product, please contact your local authorities or dealer and ask for the correct method of disposal.

Español

Deshecho de equipos eléctricos y electrónicos (aplicable a la Unión Europea y a otros países europeos con programas de reciclaje independientes)

La presencia de este símbolo en el propio producto o en su material de embalaje, indica que no se debe tratar como residuo doméstico cuando desee deshacerse de él. En su lugar, debe entregarlo en el punto limpio correspondiente de reciclaje de equipos eléctricos y electrónicos. Asegurándose de que este producto se desecha de forma correcta, ayudará a evitar posibles consecuencias negativas para la conservación del medioambiente y la salud humana, consecuencias que podrían darse si se desecha del producto de forma inadecuada. El reciclado de materiales ayuda a conservar los recursos naturales.



Este símbolo solamente es válido en la Unión Europea. Si desea deshacerse de este producto, póngase en contacto con las autoridades locales o con su distribuidor y pida información sobre el método de disposición adecuado.

Português

Eliminação de equipamentos eléctricos e electrónicos usados (aplicável na União Europeia e noutros países europeus com programas próprios de recolha destes equipamentos)

Este símbolo, colocado no produto ou na respectiva embalagem, indica que o produto não deve ser tratado como lixo doméstico aquando da sua eliminação. Em vez disso, deve ser entregue num ponto de recolha de equipamentos eléctricos e electrónicos para posterior reciclagem. Ao garantir a correcta eliminação deste produto, estará a evitar consequências potencialmente negativas tanto para o ambiente como para a saúde humana. A reciclagem de materiais ajuda a preservar os recursos naturais.



Este símbolo apenas é válido na União Europeia. Se quiser eliminar este produto, contacte as entidades locais ou o seu fornecedor para ficar a saber qual o método de eliminação correcto.

Svenska

Avfall av förbrukad elektrisk och elektronisk utrustning (Tillämpbart i hela Europeiska unionen och andra europeiska länder med separata samlingsprogram)

Den här symbolen som finns på din produkt eller på dess förpackning påvisar att produkten inte ska behandlas som hushållsavfall när du vill slänga bort den. Istället ska den lämnas över till en lämplig uppsamlingspunkt för återvinning av elektriska och elektroniska utrustningar. Genom att tillförsäkra att den här produkten återvinns på ett riktigt sätt hjälper du till med att förhindra möjliga negativa konsekvenser för miljön och mänsklig hälsa. Det kan annars orsakas på grund av olämplig sophantering av den här produkten. Återvinning av material kommer att hjälpa till att bevara naturtillgångar.



Den här symbolen är endast giltig inom den Europeiska unionen. Om du vill slänga bort den här produkten ska du kontakta lokala myndigheter eller återförsäljare, och fråga efter lämplig avfallsmetod.

Français

Mise au rebut des équipements électriques et électroniques usagés (Valable dans l'ensemble de l'Union Européenne ainsi que dans les pays européens disposant de programmes distincts de collecte des déchets)

Ce symbole appliqué sur votre produit ou sur son emballage indique que ce produit ne doit pas être traité comme un déchet ménager lorsque vous voulez le mettre au rebut. Il doit au contraire être remis à un site de collecte agréé pour le recyclage des équipements électriques et électroniques. En veillant à ce que ce produit soit mis au rebut de façon adéquate, vous contribuerez à prévenir les conséquences potentiellement négatives sur l'environnement et sur la santé humaine qui résulteraient de sa production en cas de mise au rebut inappropriée de ce produit. Le recyclage des matériaux contribuera également à économiser les ressources naturelles.



Ce symbole n'est valable que dans l'Union Européenne. Si vous souhaitez mettre ce produit au rebut, veuillez prendre contact avec les autorités locales ou avec votre revendeur et renseignez-vous sur la méthode de mise au rebut correcte.

Italiano

Smaltimento delle attrezzature elettriche ed elettroniche usate (applicabile in tutta la Comunità Europea ed altri Paesi Europei che applicano programmi di raccolta differenziata)

Il simbolo trovato sul prodotto, o sulla sua confezione, indica che il prodotto non può essere trattato come i domestici quando è il momento di smaltirlo. Al contrario, deve essere consegnato ad un centro di raccolta specializzato nel riciclaggio di attrezzature elettriche ed elettroniche. Assicurando che il corretto smaltimento di questo prodotto, si aiuterà a prevenire potenziali conseguenze negative sull'ambiente e sulla salute umana, che possono essere provocate da uno scorretto smaltimento di questa attrezzatura. I materiali riciclati aiuteranno a conservare le risorse naturali.



Questo simbolo è valido solo nell'Unione Europea. Per smaltire questo prodotto, mettersi in contatto con le autorità locali - o con il rivenditore - e chiedere informazioni sul corretto metodo di smaltimento.

Polski

Ustawienie zużytego sprzętu elektrycznego i elektronicznego (Dotyczy krajów Unii Europejskiej i innych krajów europejskich z oddzielnymi programami zbiórki odpadów)

Obecność tego symbolu na produkcie lub na opakowaniu z produktem oznacza, że tego produktu nie można wyrzucić razem z odpadkami domowymi. Należy go przekazać do punktu zbiórki w celu poddania recyklingowi produktów elektrycznych i elektronicznych. Usunięcie tego produktu w prawidłowy sposób, pomoże w zabezpieczeniu przed negatywnym wpływem odpadów na środowisko i zdrowie ludzi, powodowanym przez niewłaściwe usuwanie produktu. Przetwarzanie materiałów pomaga w zachowaniu zasobów naturalnych.



Ten symbol obowiązuje wyłącznie w krajach Unii Europejskiej. Informacje dotyczące prawidłowej metody usunięcia tego produktu, można uzyskać u władz lokalnych lub u dostawcy.

Suomi

Vanhojen sähkö- ja elektroniikkalaitteiden hävittäminen (Soveltuva kaikkialla Euroopan unionin alueella, sekä muissa Euroopan maissa, jolla on erilliset keräysohjelmat)

Jos tuotteessa tai sen pakkauksessa on tämä symboli, sitä ei pidä hävittää tavalliseen tavalliseen kotitalousjätteeseen, vaan se kuuluu toimittajan sähkö- ja elektroniikkalaitteiden kierrätysjärjestelmään. Varmistamalla, että tämä tuote hävitetään asianmukaisesti tavalla, jolla ei estäviä mahdollisia ympäristölle ja ihmisille kovia negatiivisia seurauksia, joita sen väärä hävittäminen voi aiheuttaa. Materiaalien kierrättäminen auttaa säilyttämään luonnonvarjoja.



Tämä symboli on voimassa ainostaan Euroopan unionin alueella. Jos haluat hävittää tämän tuotteen, ota yhteyttä paikallisiin viranomaisiin tai jälleenmyyjään ja tiedustele asiaankuuluvia hävittämistapoja.

Deutsch

Entsorgung von elektrischen & elektronischen Altgeräten (geltend für die europäische Gemeinschaft und andere europäische Länder mit separaten Sammelprogrammen)

Dieses Symbol, zu finden auf Ihrem Produkt oder dessen Verpackung, macht Sie darauf aufmerksam, dass dieses Produkt bei der Entsorgung nicht als Hausmüll behandelt werden darf. Statt dessen sollte es an eine Sammelstelle zum Recycling von elektrischen und elektronischen Altgeräten gegeben werden. Helfen Sie mit, potenziell schädliche Einflüsse auf Umwelt und Gesundheit, die durch eine unsachgemäße Entsorgung dieses Produktes entstehen können, zu vermeiden und entsorgen Sie dieses Produkt ordnungsgemäß. Recycling hilft, natürliche Rohstoffe einzusparen.



Dieses Symbol ist nur innerhalb der europäischen Gemeinschaft gültig. Wenn Sie dieses Produkt entsorgen möchten, wenden Sie sich bitte an Ihre örtliche Behörde und fragen Sie nach der ordnungsgemäßen Entsorgungsmethode.

Nederlands

Verwijderen van oude elektrische en elektronische apparatuur (toepasselijk in de volledige Europese Unie en andere Europese landen met afzonderlijke programma's voor afvalverzameling)

Dit symbool dat op het product of zijn verpakking is aangebracht, geeft aan dat dit product niet mag worden behandeld als huishoudelijk afval als u het wilt wegwerpen. U moet het afgeven bij een specifiek verzamelpunt voor de recycling van elektrische en elektronische apparatuur. Door te garanderen dat u dit product op de correcte manier wegwerpt, helpt u potentiële negatieve gevolgen voor het milieu en de menselijke gezondheid, die zouden kunnen worden veroorzaakt door een onrechtmatig wegwerpen van het product, te voorkomen. De recycling van materialen helpt het behoud van natuurlijke bronnen.



Dit symbool is alleen geldig in de Europese Unie. Als u dit product wenst weg te gooien, dient u contact op te nemen met uw lokale instanties voor details over de gepaste methode voor afvalverwijdering.

Waste Electrical and Electronic Equipment (WEEE) Directive In the European Union, this label indicates that this product should not be disposed of with household waste. It should be deposited at an appropriate facility to enable recovery and recycling. EEE complies with Directive 'Regulation on the Restriction of the Use of Certain Hazardous Substances in Electrical and Electronic Equipment'



Waste Electrical and Electronic Equipment (WEEE) Directive In the European Union, this label indicates that this product should not be disposed of with household waste. It should be deposited at an appropriate facility to enable recovery and recycling. EEE complies with Directive 'Regulation on the Restriction of the Use of Certain Hazardous Substances in Electrical and Electronic Equipment'

Waste Electrical and Electronic Equipment (WEEE) Yönergeleri Avrupa Birliği'nde bu etiket, ürünün ev elektroniği aletleri atıkları ile imha edilemeyeceğini gösterir.

Kurtarmak ve geri dönüştürmeyi sağlamak için uygun şartlarda saklanması gerekir. EEE Yönetmeliğine Uygunluk Ve Elektronik Eşyalarla Bazi Zararlı Maddelerin Kullanımının Sınırlanmasında Dair Yönetmelik.



Waste Electrical and Electronic Equipment (WEEE) Yönergeleri Avrupa Birliği'nde bu etiket, ürünün ev elektroniği aletleri atıkları ile imha edilemeyeceğini gösterir. Kurtarmak ve geri dönüştürmeyi sağlamak için uygun şartlarda saklanması gerekir. EEE Yönetmeliğine Uygunluk Ve Elektronik Eşyalarla Bazi Zararlı Maddelerin Kullanımının Sınırlanmasında Dair Yönetmelik.

❖ Cautions for consisting

Environmental condition for installation

- Since monitor is very sensitive for physical impact, installation requires considerable caution.
- Minimum clearance(20cm) must be secured for smooth ventilation. (See page 6) Installation must avoid air tight or near air tight places. Improper ventilation causes malfunction and shortens product lifetime by rapid internal temperature rise. If monitor has to be installed at the improper ventilation, additional ventilation openings or fans must be provided to keep the internal temperature between 0 ~ 35°C.
- For ground of monitor and application devices, it should be connected as frame ground.
- Considering monitor Max power consumption, check the main electric specification .

Recommended Operating Condition

- Temperature: 5~35°C, Humidity: 35~75%, Suitable operating time : under 24 hours a day.
- Do not install the set at the air-tight condition.
- It is recommended to install the set with good ventilation.
- Do not install the set at the place of direct sunlight or excessive exposure to lightings.
- ❖ Blackening, stains or burning effect on the screen can be occurred by improper installation or use against the above recommended conditions.

Consideration for easier service

- When you design the exterior design for monitor system, consider easier disassembly for possible service occasion in the future.
- The sliding Universal Unit of ORION is recommended for easier service.
- If service people can step into the backside of monitor system, it can greatly reduce time and effort for service.
- In case of higher locations, consider the installation location and exterior design for easier service.

WARNING

WARNING

※ Clearance for Ventilation



- When you install monitor make sure there is at least 20cm clearance for effective ventilation and do not seal off monitor sets.
 If monitor sets are installed at the locations of bad ventilation, the inner temperature can be raised rapidly and it can cause frequent malfunctions and rapid reduction of the product life.

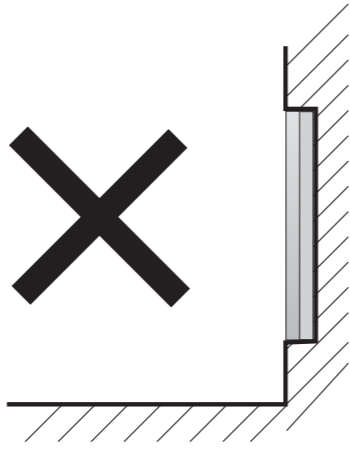
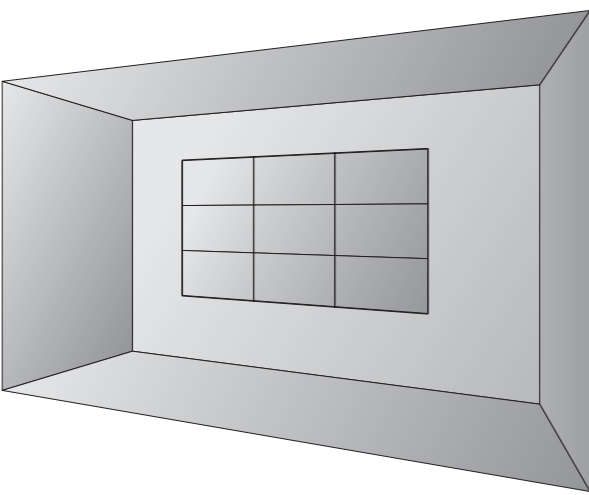
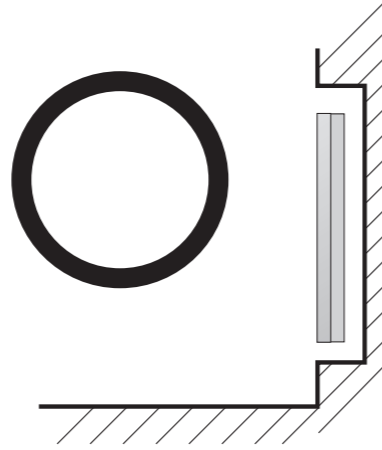
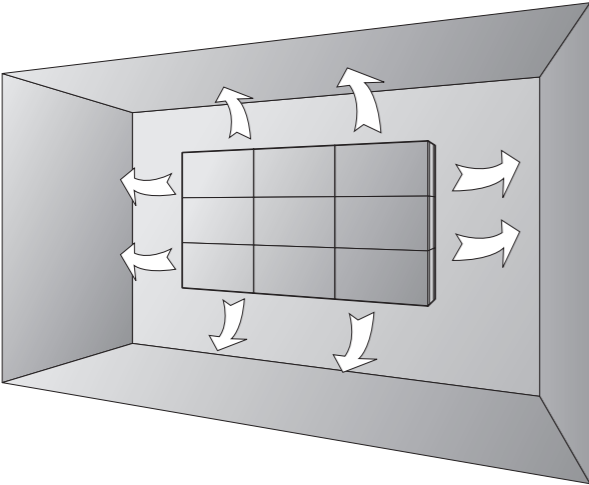

※ Ventilation space in front of monitor must be furnished for heat dispersion. If the front space of monitor has to be sealed, there must be consideration for the heat dispersion in the rear side of monitor.

※ Cleaning and Maintenance



- Regularly clean off the vent holes in the back of monitor sets.
 If the vent holes and the fan air holes are clogged with dust, it prevents the air flow inside of monitor sets.
 It can cause rapid increase of the inner temperature and may cause malfunctions.
 Clean off the vent holes and the fan air holes with a vacuum cleaner regularly.

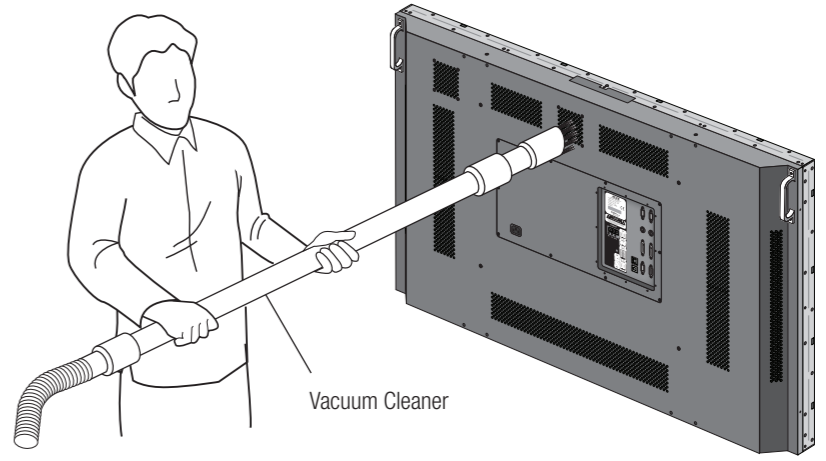



※ Please keep following instruction for panel protection without exception.

- This product can be damaged even with minor impact for its nature. Please keep following instruction to carry or store the products.

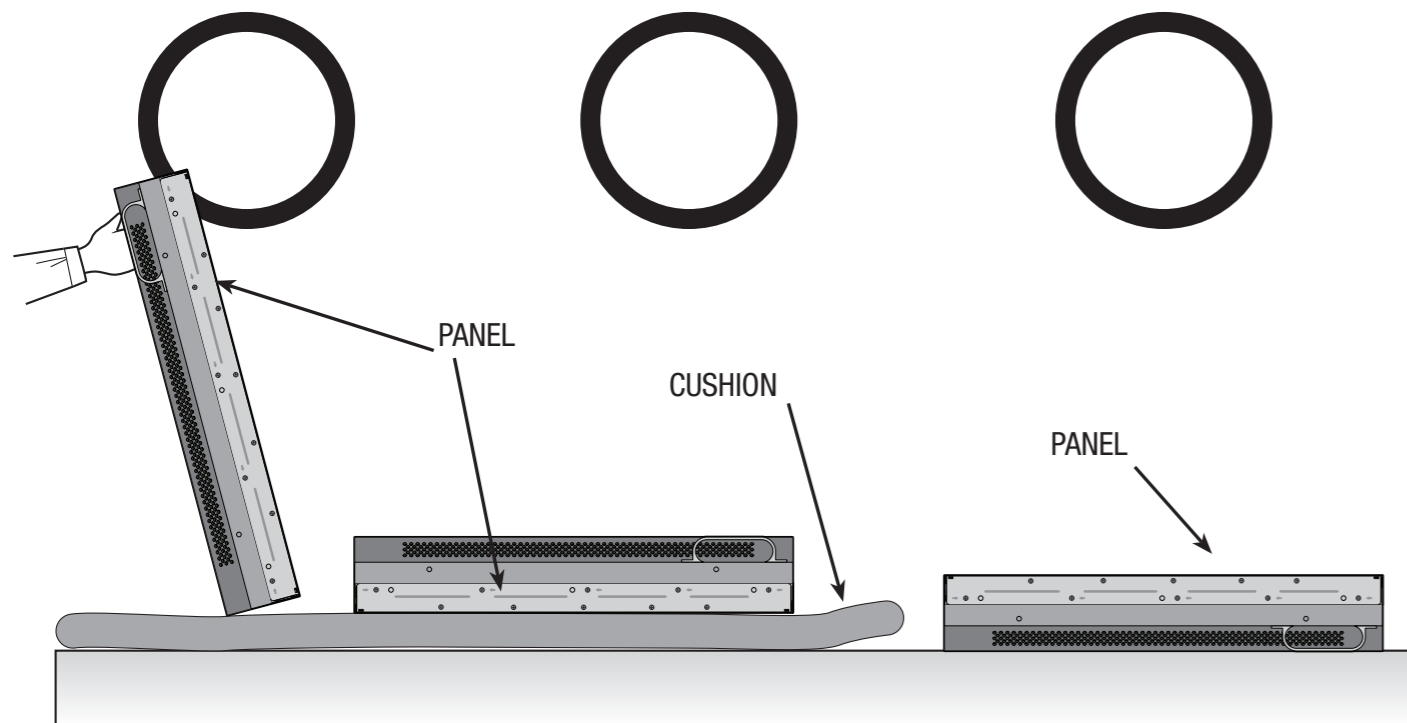

- If you need to stand LCD, you must lean over the LCD to avoid panel touches ground or floor .
- If you need to lay down LCD as face down position, please use shock-absorbing pads under the LCD.
- If you need to lay down LCD as face up position, please be cautious for falling objects on the surface of the LCD.



※ Handle with Caution.

- Shock/Impact on the set's sides will result in internal circuit damages.
- The edge/bottom of the panel are fragile. Use shock-absorbing pads or rugs for laying down the product.

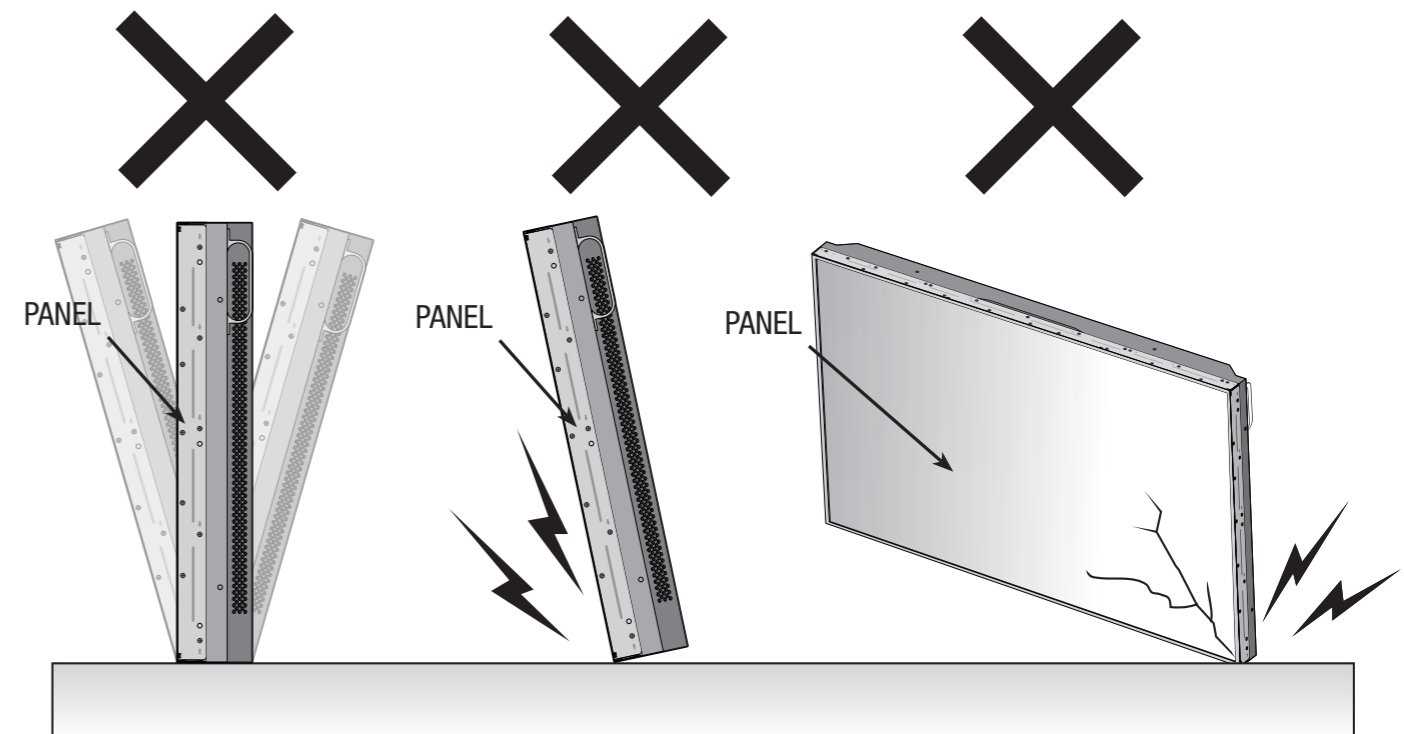

- Please do not stand LCD alone. It may fall or slip off and Panel can be broken or damaged.
- Please do not lean over the LCD. It may damage the bottom part of the LCD.
- Please do not lean over the LCD toward the edge part. It may damage the edge part of the LCD.

※ How to carry

It always needs two persons to carry or install monitor .

When you carry monitor with up straight manner, please hold handles on the back and bottom part of the panel together.

Please be careful not to touch the bottom part of the panel when you put down the panel.

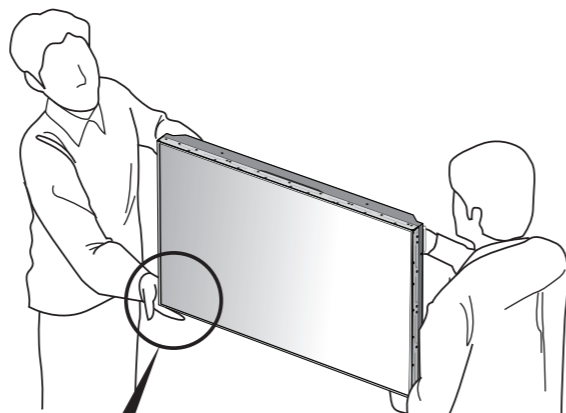

Please do not touch the panel with your hand.

Don't carry monitor in Horizontal Status.

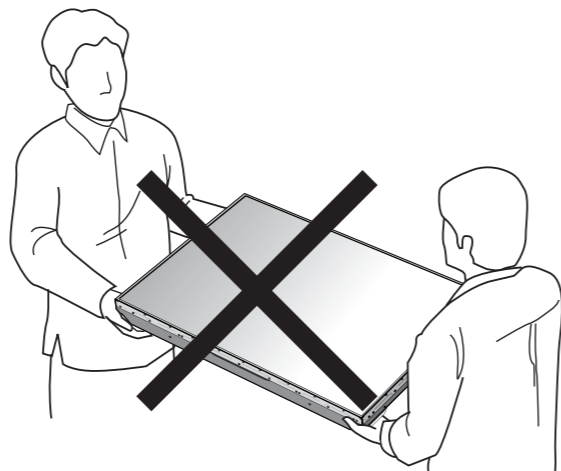

When two operators uphold monitor, Panel is twisted by unbalanced handling.

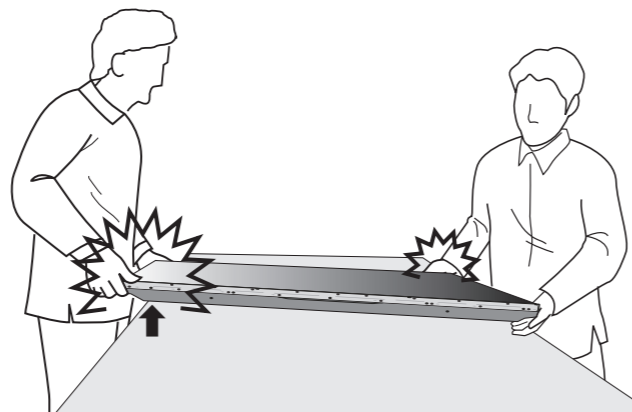

※ Application information

If static images are displayed on the screen for a long time, it causes burn-in image. Please keep the following instruction to optimize the lifetime and functions of the product.

1. Operating condition

- Temperature: 20 ± 15°C
- Humidity: 55 ± 20 %
- Display pattern: moving picture or regular switchover display
- Environmental condition : Well ventilated place is recommended.
- Power off and screen saver : Periodical power-off or screen saver is needed after long-term static display.

※ Note : Moving picture or black pattern is strongly recommended for screen saver.

2. Operating methods to minimize burn-in image due to long-term static information display

- For optimal performance, we suggest turning off the LED power on the monitor for four hours per day
- Periodical display contents change from static image to moving picture.
- Periodical background color and character (image) color change

DEPARTURE			DEPARTURE		
Flight No.	Time	Gate	Flight No.	Time	Gate
UA 012	11:20	A02	UA 012	11:20	A02
KE 732	12:10	K17	KE 732	12:10	K17
AN 291	12:45	F11	AN 291	12:45	F11

- Change the images of little luminance difference between the background and characters, periodically.

DEPARTURE			DEPARTURE			DEPARTURE			DEPARTURE		
Flight No.	Time	Gate	Flight No.	Time	Gate	Flight No.	Time	Gate	Flight No.	Time	Gate
UA 012	11:20	A02	UA 012	11:20	A02	UA 012	11:20	A02	UA 012	11:20	A02

- It is not recommended to display the images of huge luminance difference between the background and characters or the images of grey tone.

ARRIVAL				ARRIVAL			
Flight No.	Time	Gate	Delay	Flight No.	Time	Embark	Delay
AA 213	9:20	K11	On time	AA 213	9:20	New York	On time
OZ 621	11:25	G21	10 min.	OZ 621	11:25	Seoul	10 min.
JA 032	12:05	A19	On time	JA 032	12:05	Beijing	On time

- Scroll the characters periodically.

DEPARTURE			DEPARTURE DEPARTURE DEPARTURE			DEPARTURE		
Flight No.	Time	Gate	Flight No.	Time	Gate	Flight No.	Time	Gate
UA 012	11:20	A02	UA 012	11:20	A02	UA 012	11:20	A02
KE 732	12:10	K17	KE 732	12:10	K17	KE 732	12:10	K17
AN 291	12:45	F11	AN 291	12:45	F11	AN 291	12:45	F11

(Whole Screen Scroll)



※ Attention for Installing

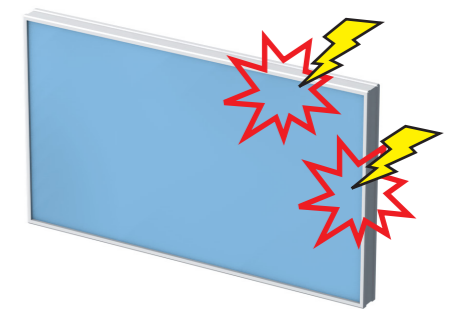
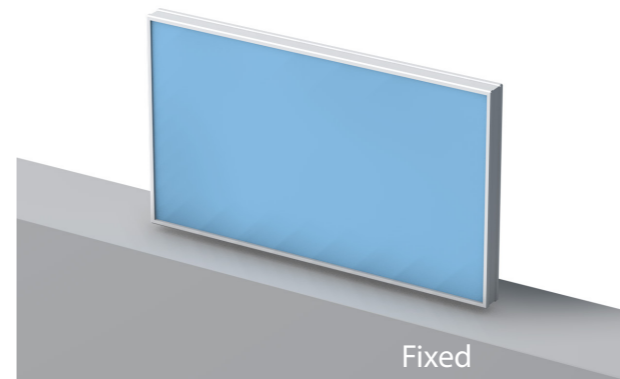
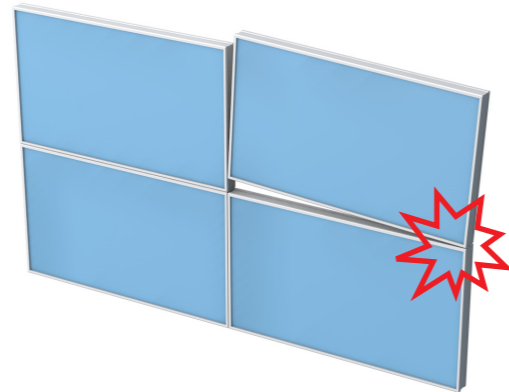
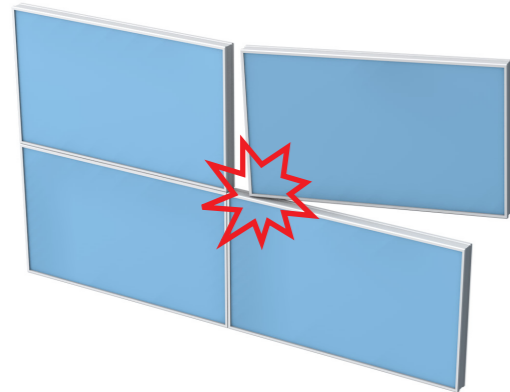

- Avoid giving a shock or damage at LCD corner or other parts during setting Multi-Vision.

- Keep all LCDs balanced in vertical or horizontal force after setting
- Multi-Vision. Avoid LCD is set up tilted so it can give a damage to down LCD.

- Avoid that LCD is twisted.

- Avoid that LCD outside is shocked or damaged by sharp thing.

1. Safety Precautions

- If it operates abnormally, stop using it immediately.

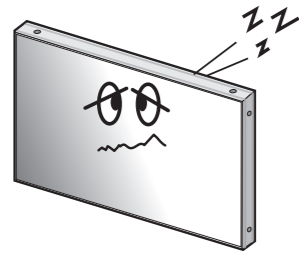

- Do not place any liquid-containing container on it. If the inside is wet, it may cause electric shock or fire.

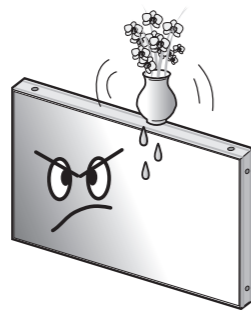

- Do not put any foreign material into the product. It may cause a failure or shorten the life span.

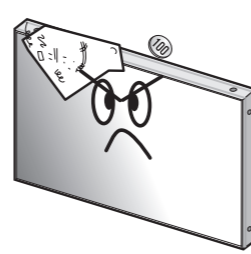

- Please refer to a specialized construction company for installing stand or wall mount unit. Otherwise, damage or injury may be caused.



- Do not touch the device when lightning strikes.

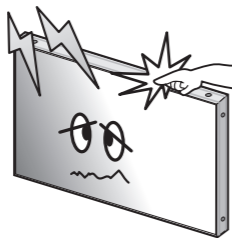

- Do not install in an unstable location. It may cause injury.

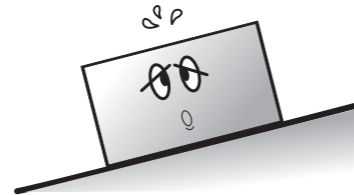

- Avoid any action to damage the power cord or power plug. It may cause fire or electric shock.

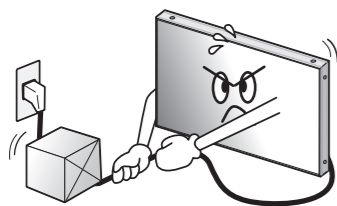

- Do not pull out the power plug with a wet hand. It may cause electric shock.



- Do not exceed ratings of AC outlet or extension cords. It may cause failure.

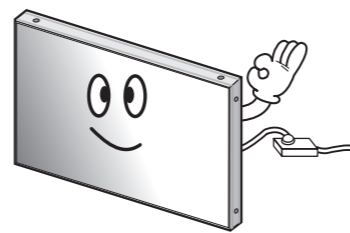

- Do not alter (or disassemble) the product. It may cause electric shock since high voltage is flowing inside.

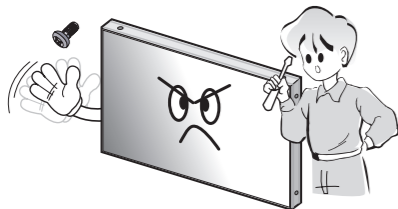

- Do not install the product where it may be exposed to direct sunlight or near any heating device. It may shorten the product's life span or cause failure.

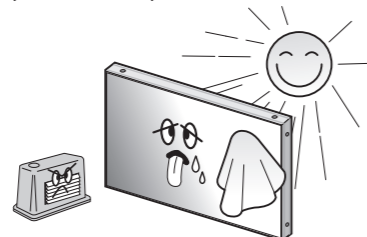

- Make sure the product is not covered with any object. If the ventilation hole is blocked, the inside temperature may rise to cause overheating resulting in fire.



- Do not pull out or hang down the connection cable. It may damage the cord to cause fire or electric shock.

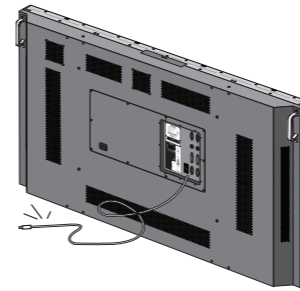

- Do not lean against the product or keep it leaned. It may cause injury or failure.

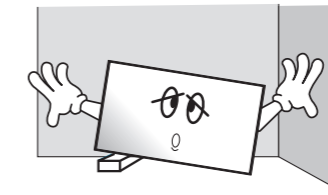

- Do not put it at any place with much humidity, dust, oil, smoke or steam. It may cause failure.

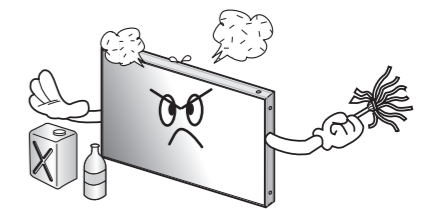

- Pull out the power plug by holding the plug. Otherwise, it may damage the power cord to cause fire or electric shock.

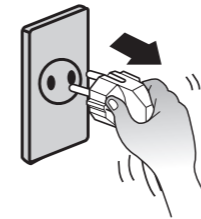

- If you do not want to use the product for a long time, keep the power plug unplugged to save electricity.
- The socket-outlet should be installed near the equipment and be easily accessible.

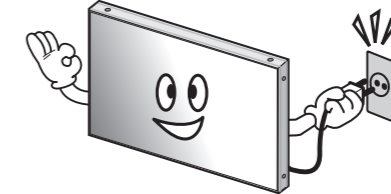

- Do not put any heavy object on it. It may cause failure.

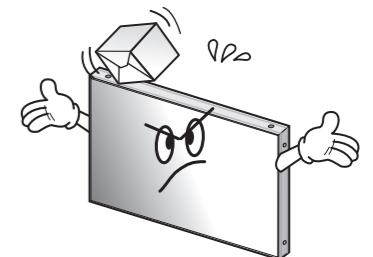

- Install the product on safe and flat surface.

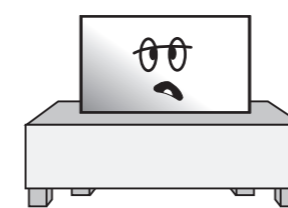

- Do not ride or step on the product. It may cause breakage when fallen down.

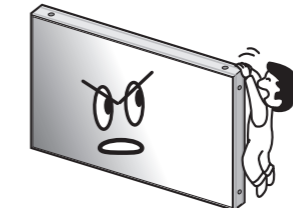

- When moving it, disconnect the connecting cable. Otherwise, it may damage the cable to cause fire or electric shock.

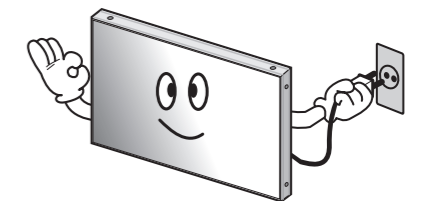

- Do not put candles on the product. If the liquid flows inside the product. It may cause electric shock or fire.

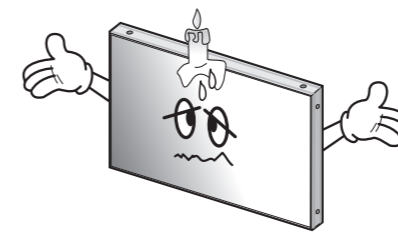

- Do not touch product's front surface with hand. Otherwise, the image quality can be lowered.

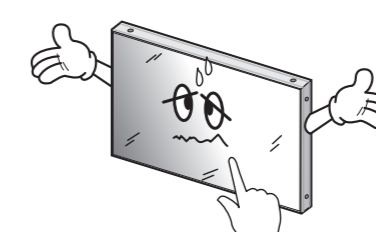

- Do not poke the front screen with sharp material. It may damage the screen and may cause malfunction of the product.

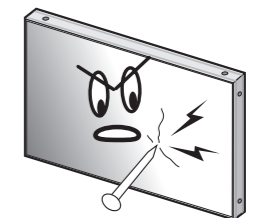

2. Names

▶ Front



▶ Rear

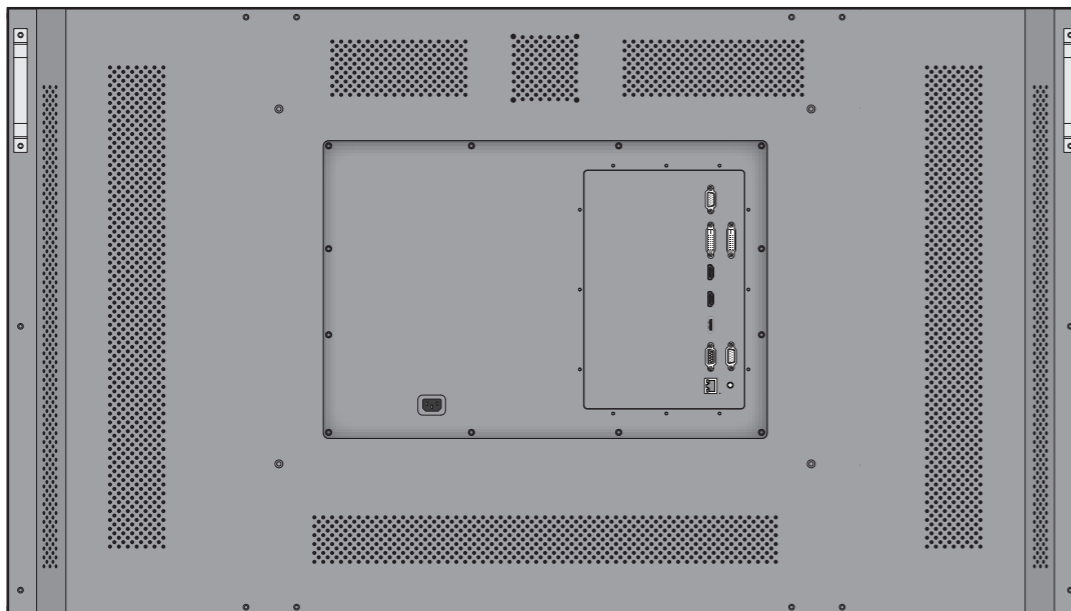

▶ Input Ports

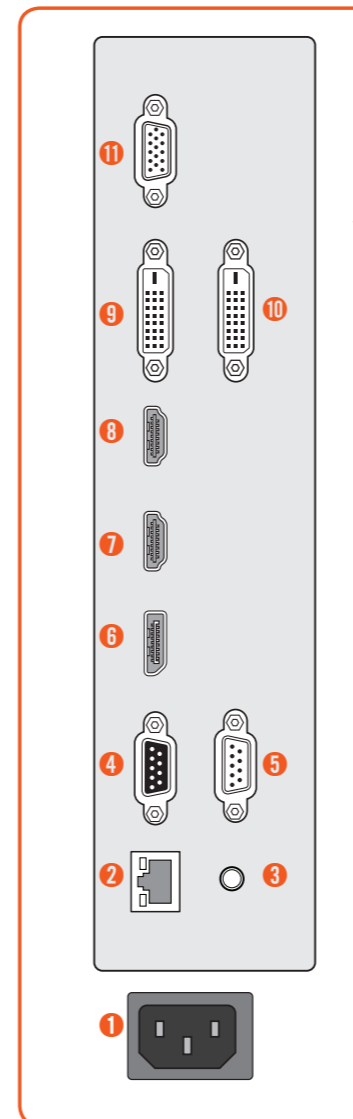
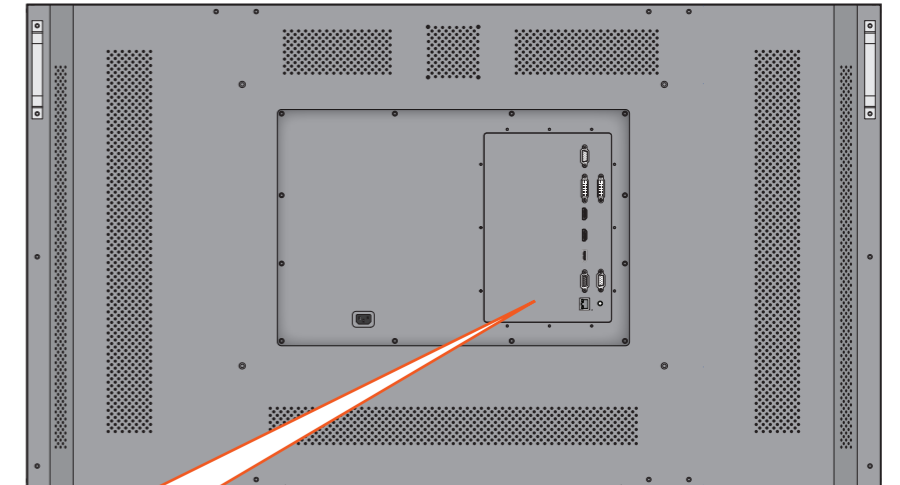

1. AC IN
AC 100V ~ 240V, 50/60Hz

2. LAN
Display control via Ethernet (RJ45)

3. IR (Option)
Remote controller input port

4. RS-232C IN
Display control via COM port
(D-Sub 9pin, FEMALE)

5. RS-232C OUT
Display control via COM port
(D-Sub 9pin, MALE)

6. DP IN
To input Display Port signals

7. HDMI 1-IN
To input digital HDMI signals

8. HDMI 2-IN
To input digital HDMI signals

9. DVI IN
Digital RGB Signal,
DVI Single Link 24Pin

10. DVI OUT
Digital RGB Signal,
DVI Single Link 24Pin

11. PC IN
Analog RGB Signal,
D-sub 15pin

3. How to Connect Cables

- Do not connect/disconnect cables while monitor or other external equipments are turned on.
- First turn off the power all the attached equipment and make connections.
- Make sure the power cord is inserted properly into the power inlet to prevent unexpected pullout of the cord.

3.1. Connection of Single

- Monitor and PC should be connected; a Com Port in a PC and RS-232C IN port in a monitor is connected with supplied RS-232C cable.
- If you do not have Com Port, you need to use a USB converter for RS-232C. Depending on manufacturers or models, converters may cause malfunction.

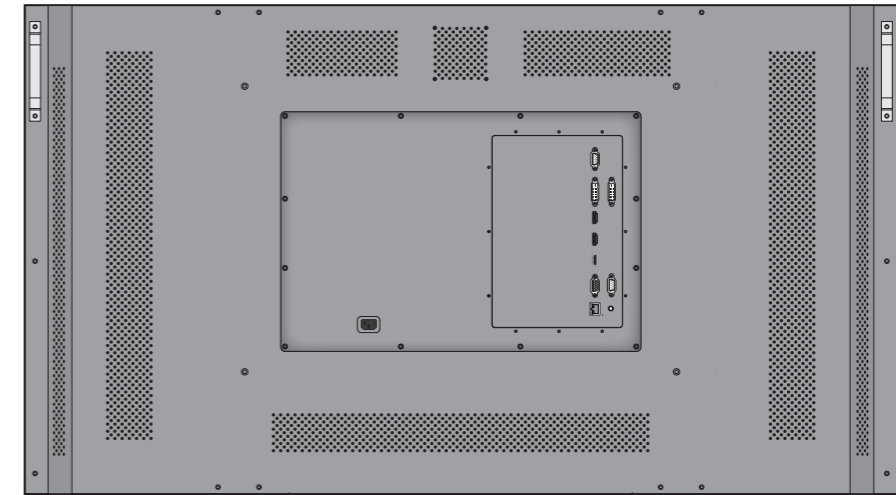

Control PC



DVD player

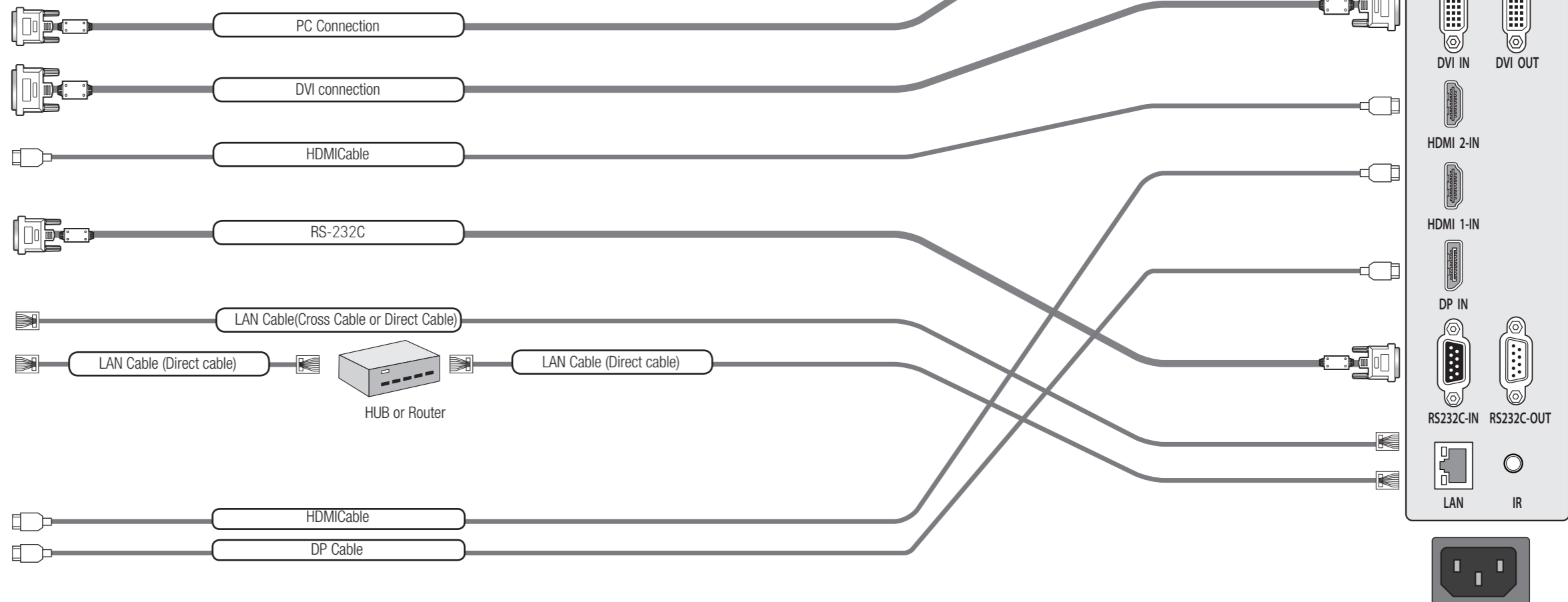

3.2. Connection of Multiple (for DP in)

- Image quality can be affected by cable or signal quality.
- Please use DisplayPort cable with DisplayPort certified logo.
- Select DisplayPort cables feature a locking function. When removing this cable, hold down the top button to release the lock.

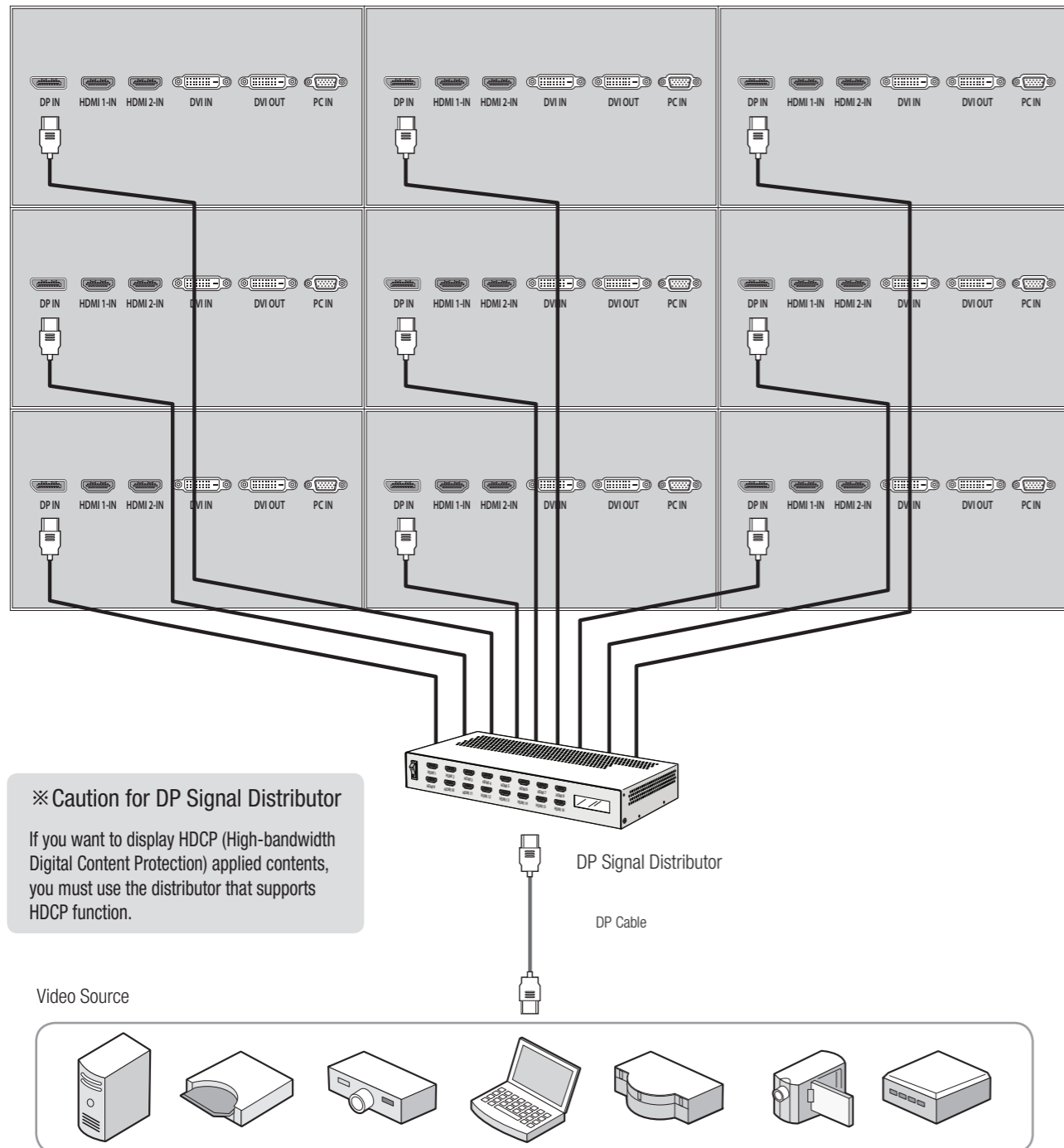

3.3. Connection of Multiple (for HDMI in)

- It is recommended you purchase an HDMI-certified cable. Otherwise, the screen may appear blank or a connection error may occur.
- Recommended maximum set connection for Multi setting is shown in table below. If you need to connect more than described in the table, you have to use distributors.
- Image quality can be affected by cable or signal quality.

INPUT SOURCE	Resolution	Output Port	Connection	Remark
DVI	1600 x 1200 x 60Hz	DVI OUT	12 sets	HDCP Available

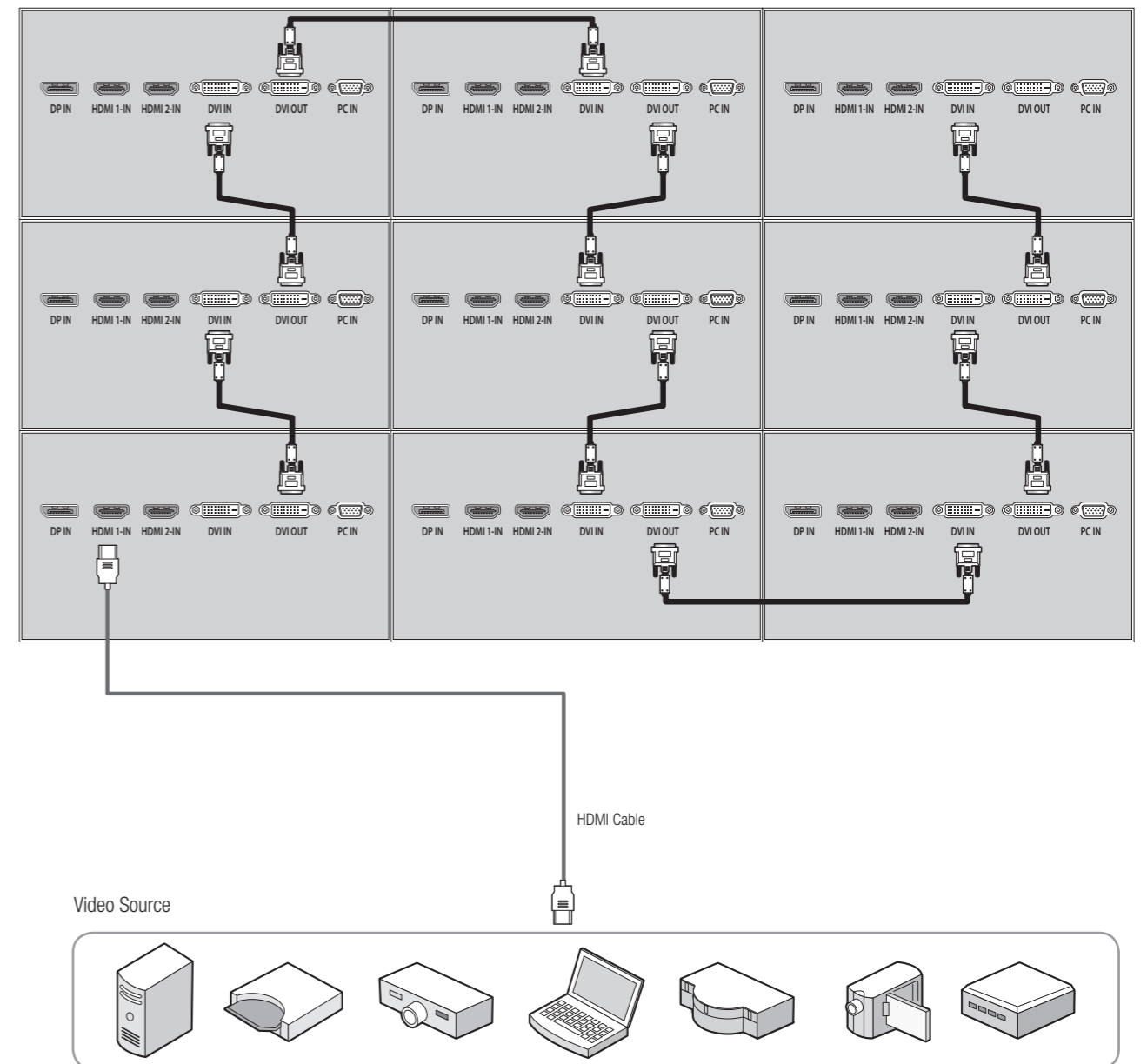

3.4. Connection of Multiple (for DVI in)

- Recommended maximum set connection for Multi setting is shown in table below.
If you need to connect more than described in the table, you have to use distributors.
- Image quality can be affected by cable or signal quality.

INPUT SOURCE	Resolution	Output Port	Connection	Remark
DVI	1600 x 1200 x 60Hz	DVI OUT	12 sets	HDCP Available

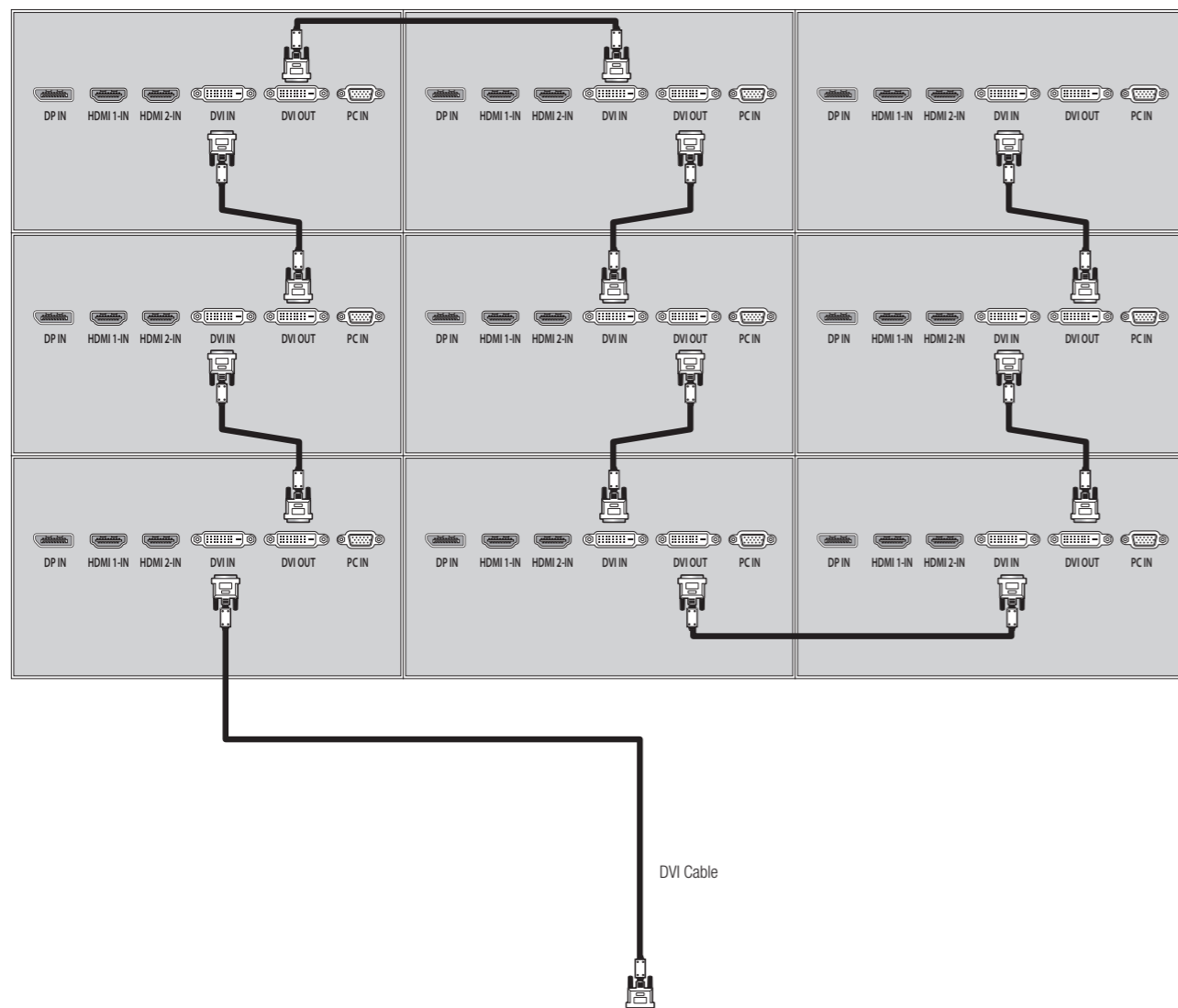

Video Source

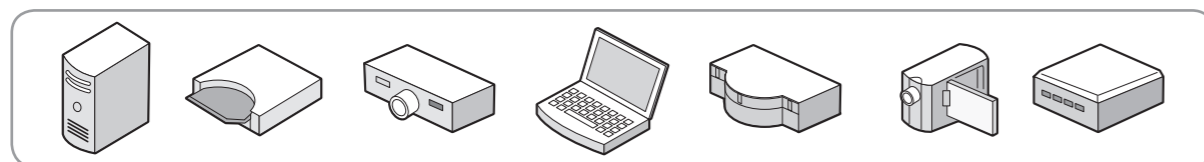

3.5. Connection of Multiple (for PC in)

- Image quality can be affected by cable or signal quality.

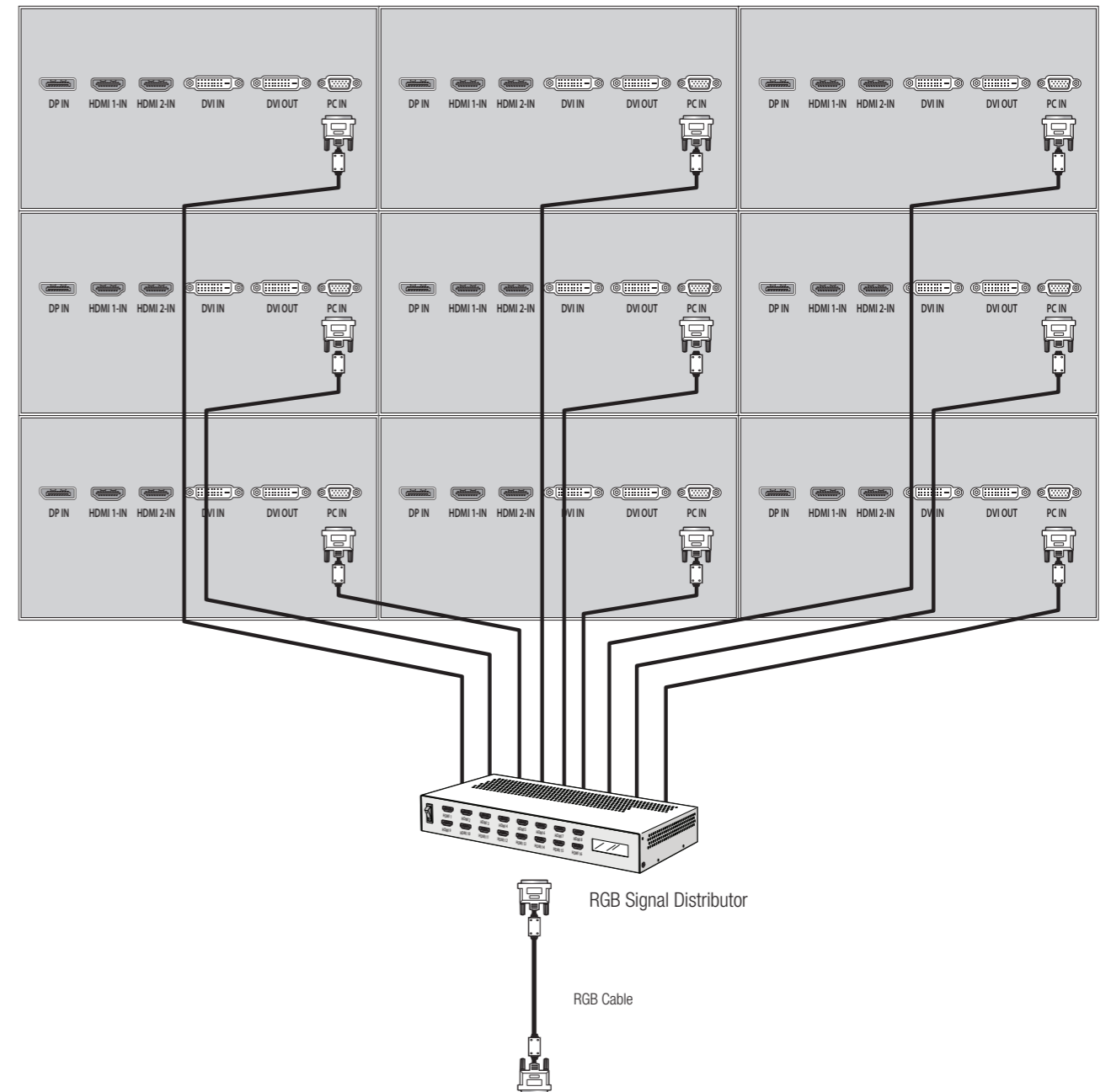

Video Source

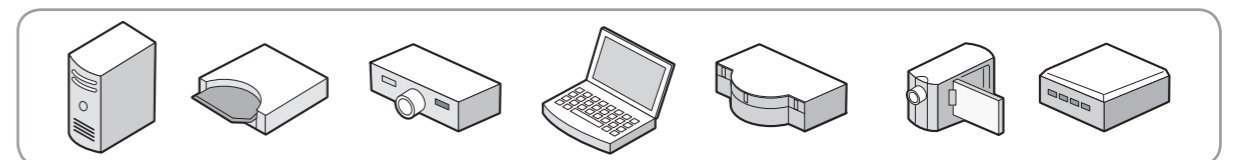

3.6. Connection of Control Cable

- Control signal transmission can be connected by 3 different methods.(RS-232C or Ethernet or IR)
- RS-232C and Ethernet connection cannot be used simultaneously.
- All control signals are output to the RS-232OUT after conversion to RS-232C signal.

3.6.1. Connection of RS-232C Cable

- Maximum use of RS-232C with Daisy Chain connection is 30 sets or less, if you need additional connection, use RS-232C distributor.

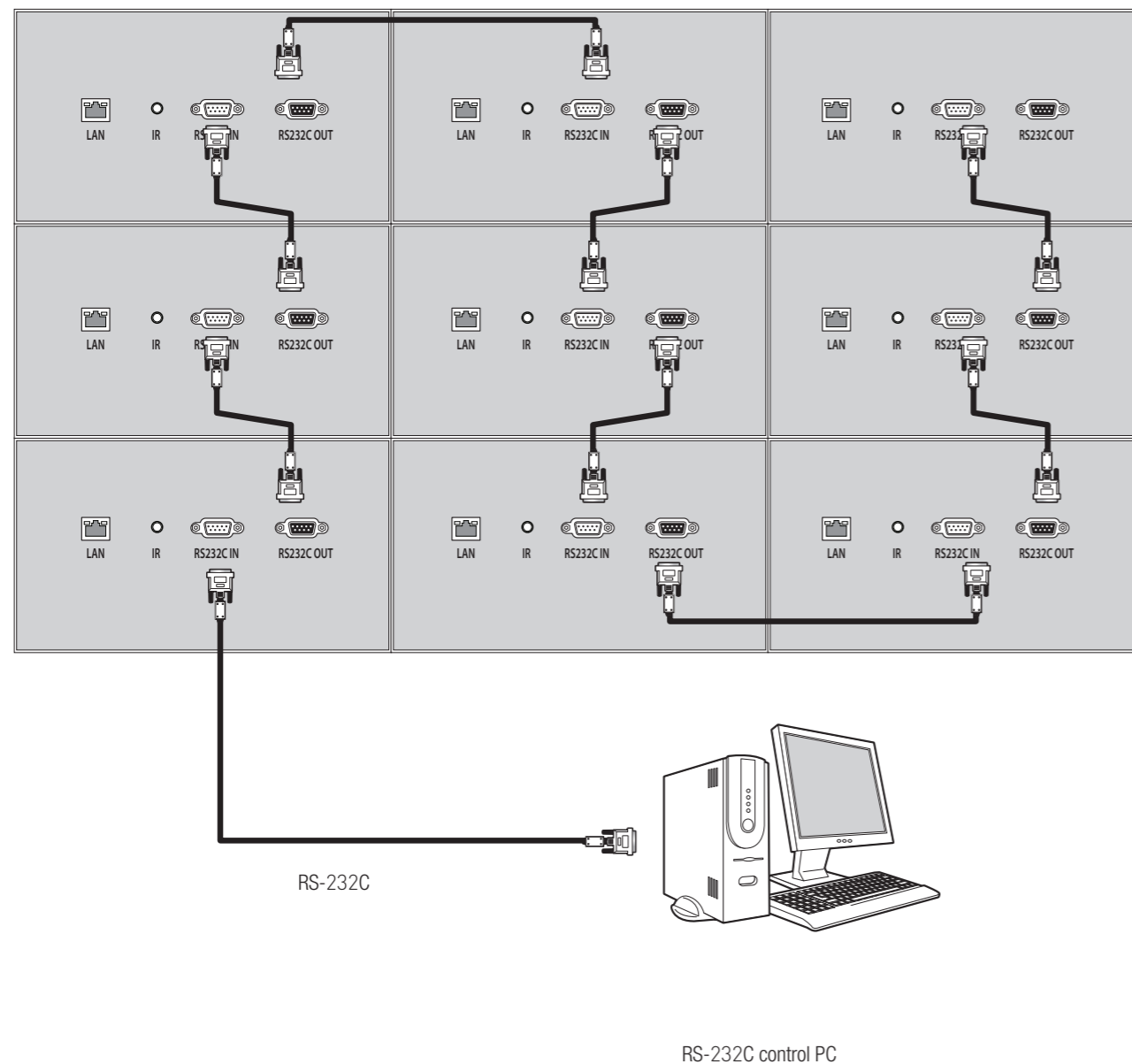

3.6.2. Connection of Ethernet Cable

- In case of Ethernet connection, the control PC should be connected to one of monitor sets with Ethernet cable. For the connection between the monitor sets, they should be connected with RS-232C cables.

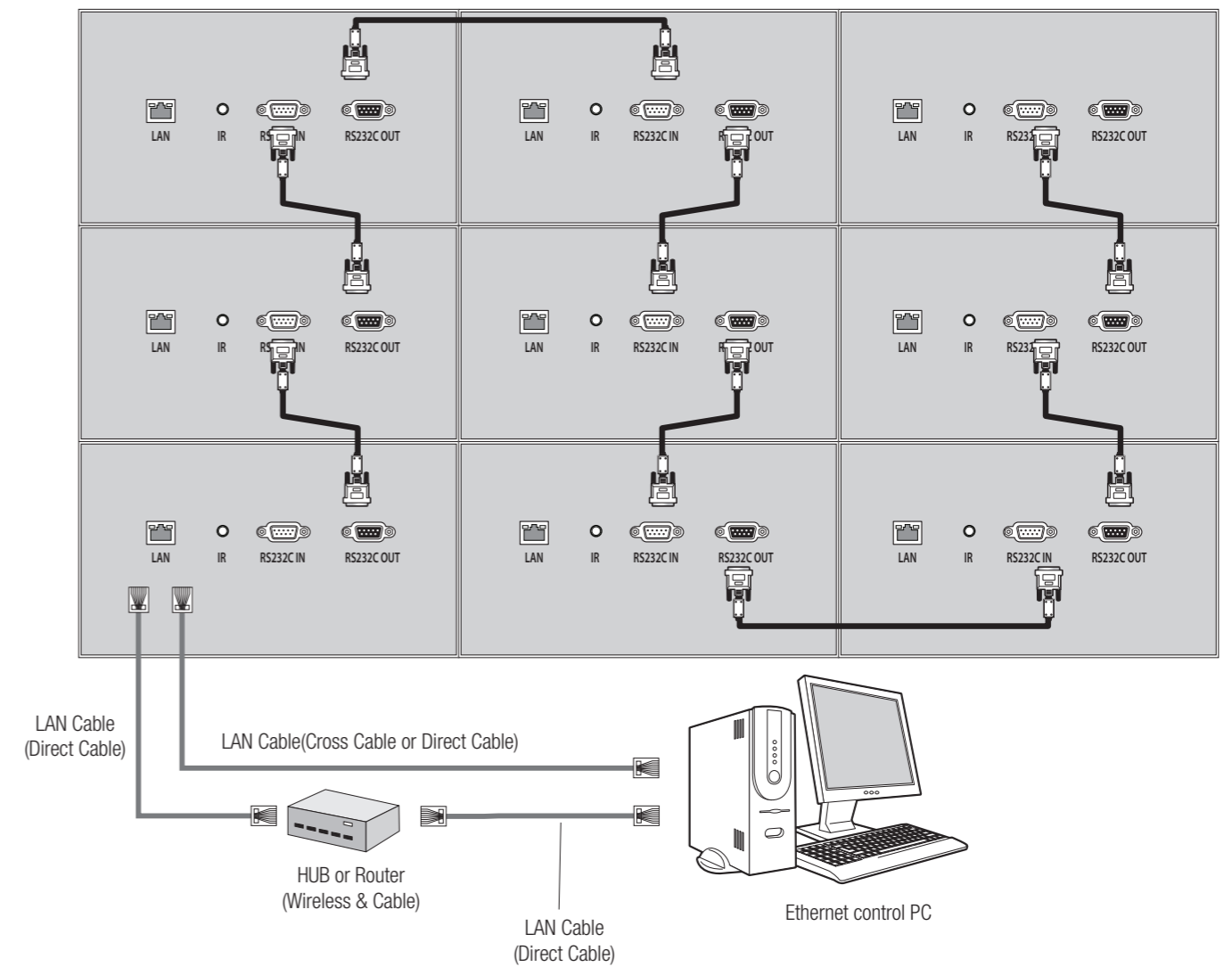

4. ID Setting

- Refer to the next chapter for MSCS use.(5.1 ~ 5.5)
- Before ID Setting, Make sure that all of the connected MLCD sets are turned on by clicking "Power On" button in Broadcast.

4.1. Sequential Connection

- It is the sequential RS-232C cable connection according to the order of ID numbers.

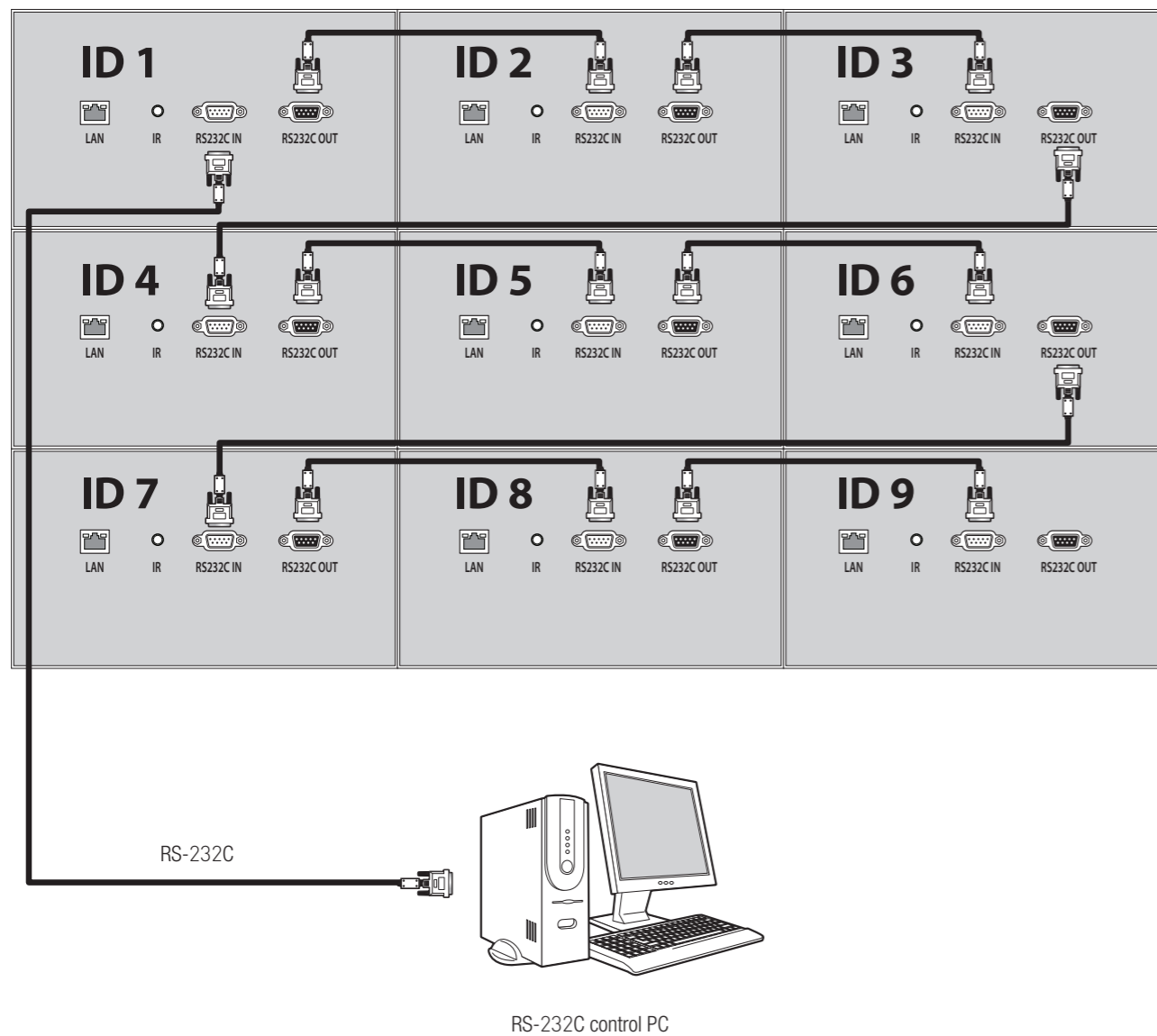

1. MSCS → Control → ID Set up
2. Click "AUTO SET ID" in Auto Start ID menu to complete ID setting.

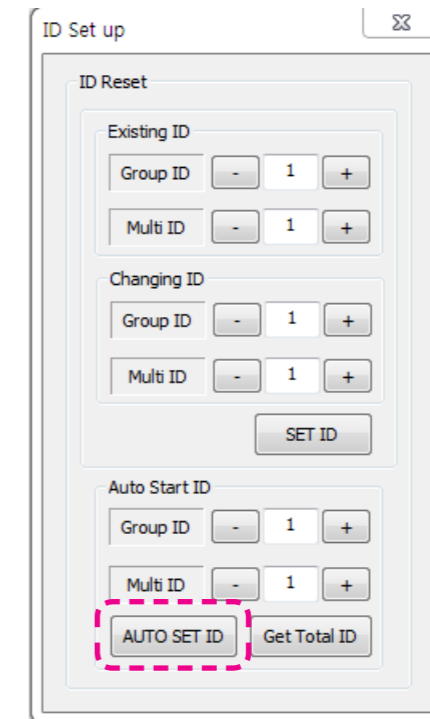

3. After that, ID setting status in MSCS Screen Configuration is as follows. It's same as physical RS-232C cable connection. Because "AUTO SET ID" sets the order of ID numbers according to the sequential RS-232C cable connection.

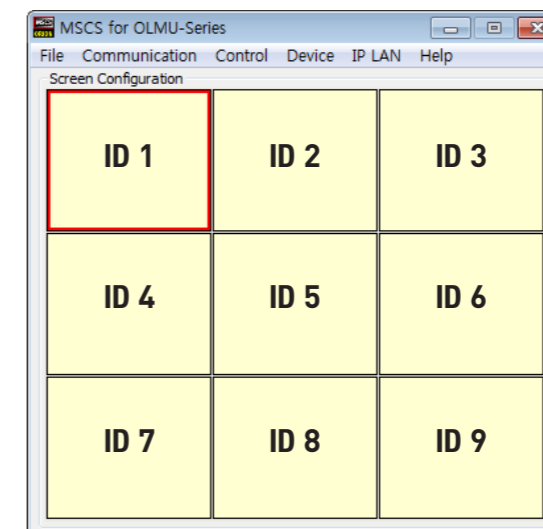

4.2. Random Connection

- It is the random RS-232C cable connection regardless of the order of ID numbers.

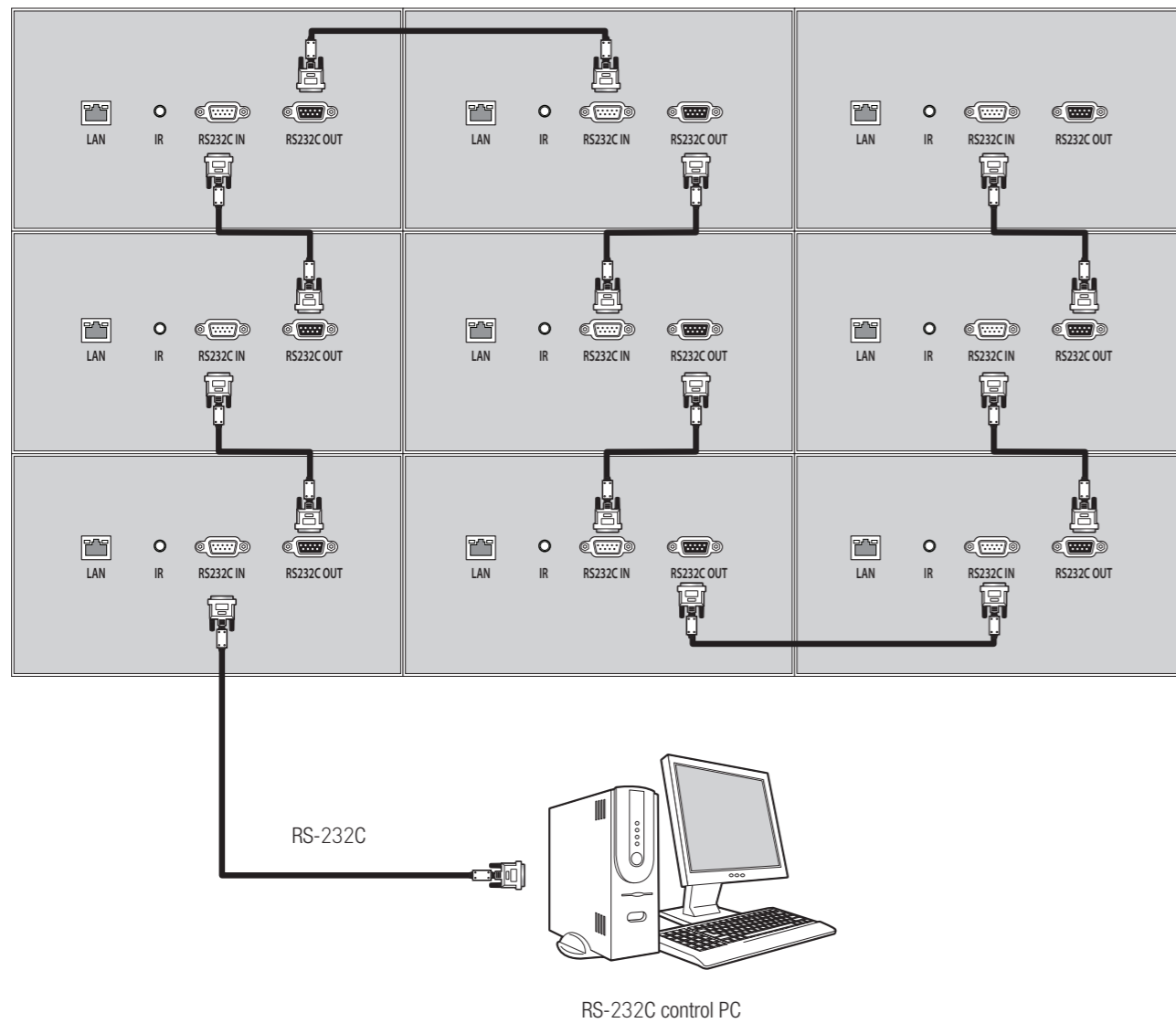

- MSCS -> Control -> ID Set up
- Select another number, which is not in use, for Group ID in Auto Start ID menu and click "AUTO SET ID"

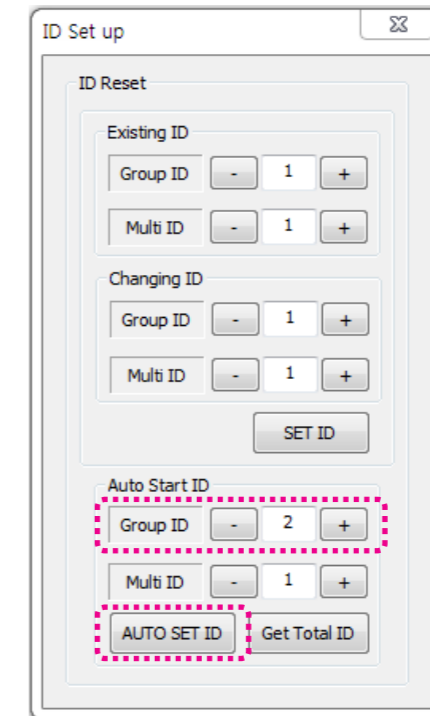

- After that, ID setting status in MSCS Screen Configuration is as follows. It's same as physical RS-232C cable connection. Because "AUTO SET ID" sets the order of ID numbers according to the sequential RS-232C cable connection.

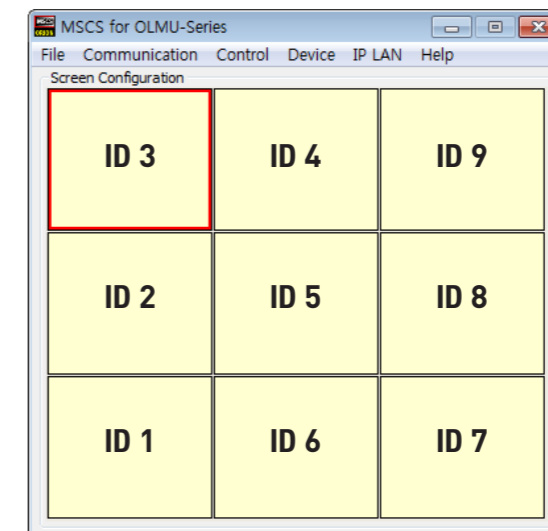

4. Identify the IDs of all connected MLC D sets by clicking "INFO" button in Broadcast.
5. first, Identify the IDs of upper left corner MLC D set.
6. Set the IDs in Existing ID Menu identified through the above 4) procedure. And then, set Group ID as 1 and Multi ID as 1 in Changing ID Menu. And click "SET ID" button.

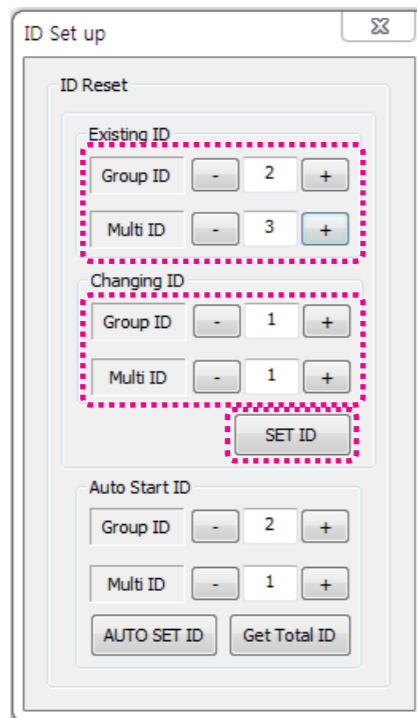

7. Identify the IDs on the right MLC D set of upper left corner MLC D set in the same way as the above 4) procedure.
8. Set the IDs in Existing ID Menu identified through the above 7) procedure. And then, Increase the number by 1 for Multi ID in Changing ID Menu to set the ID order. and click "SET ID" button.

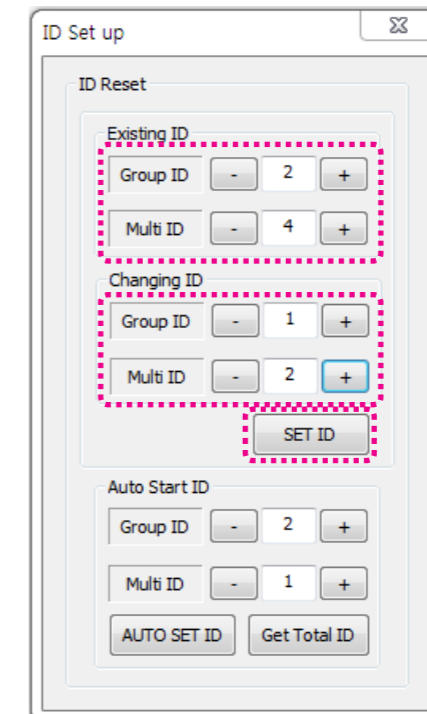

9. Repeat the above 7) and 8) procedures for the rest of displays in the same order as the number of the 10) procedure's capture view.
10. After setting last MLC D set, ID setting status in MSCS Screen Configuration is as follows. It's different from physical RS-232C cable connection.

MSCS for OLMU-Series					
File	Communication	Control	Device	IP LAN	Help
Screen Configuration					
ID 1	ID 2	ID 3			
ID 4	ID 5	ID 6			
ID 7	ID 8	ID 9			

5. Setting and operation of MSCS software

5.1. Installation

- Insert the Installation CD.
- You can see following installation start screen.
- Select proper version for your product and start installation

- MSCS supports Windows® 2000, Windows® XP and Windows® Vista, Windows® 7™ only



MSCS Installation start screen.

※ MSCS Versions can be changed for function improvement without prior notice.



Caution for using MSCS

1. Data for Picture control, Manual Tracking and so forth can be read by clicking the right button of your mouse on the desired MLCD set from MSCS.
Please do not use above function together with the other functions.
2. When you off AC power, execute power off by MSCS first and disconnect AC power to save your configuration.

5.2. Start MSCS

- MSCS is an application program needed to control MLCD.
- When you execute MSCS (v 11.60) for your product at the installation screen, it will create a new folder at *C:/Program File/MSCS (v11.60)* and an icon on your computer screen.
- By double clicking the MSCS (v11.60) icon, the initial screen image of MSCS (v11.60) will be displayed as shown in the picture.

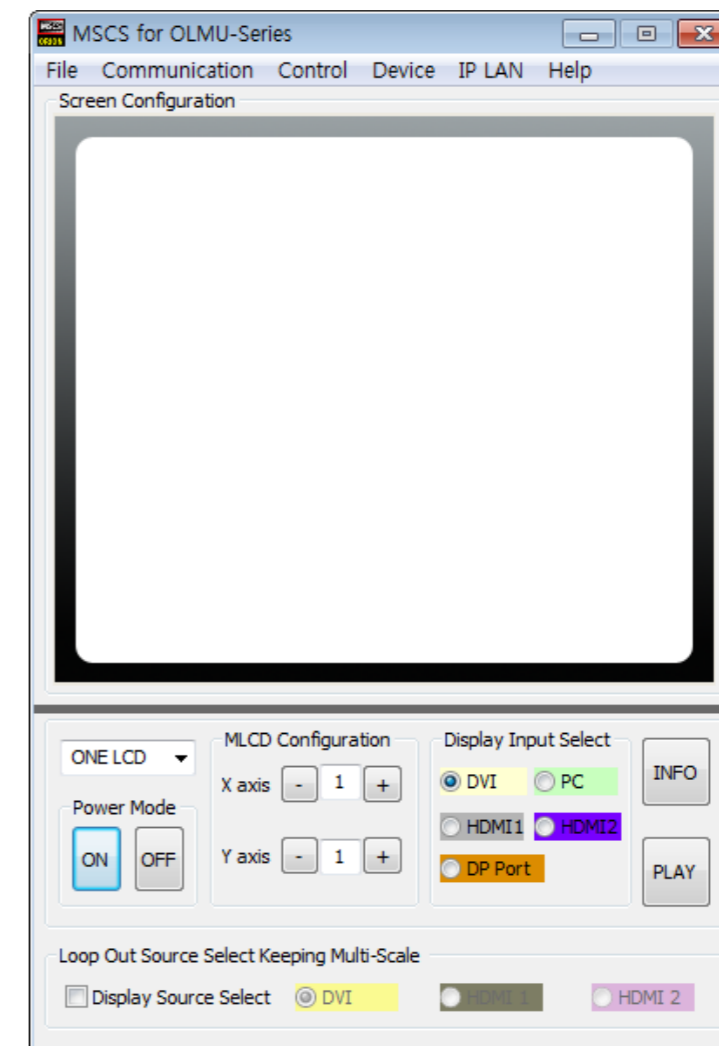

Main Image of MSCS (Multi Screen Control system)

5.3. Communication Configuration

5.3.1. COM Port For MSCS

- Com Port connects or disconnects the communication between PC and MLCD.
- Connect MLCD to PC Com Port via RS-232C cable.

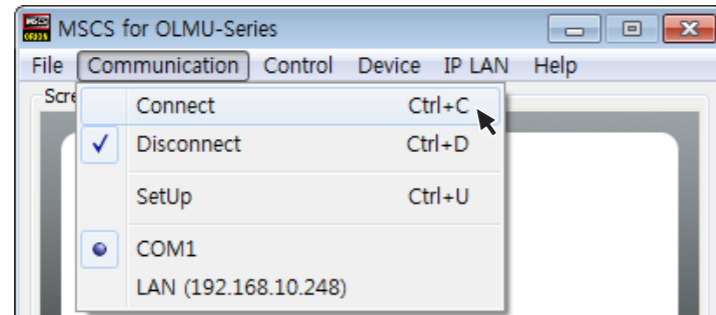

- Go to MSCS Menu → Communication and set Com Port. Click 'Connect' using mouse or press 'Ctrl+C' using keyboard.
- In order to disconnect communication, click 'Disconnect' using mouse or press 'Ctrl+D' using keyboard.
- **When you use USB-to-RS-232C converters, you need to set Com Port again, because MSCS uses one of Com Port no. 1 to 30.**

※ Available Com Port on the PC is automatically recognized and displayed.

- Com Port Configuration

Baud Rate	115200bps(Fixed)
Data Bit	8Bits
Parity	None
Stop Bit	1Bit
Flow Control	None

5.3.2. LAN Port for MSCS

1. Execute the MSCS.
2. Select "Menu→Communication → Setup" or "Ctrl+U" to start setup.

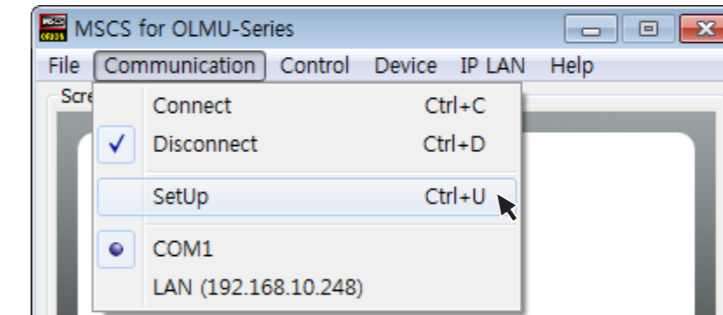

3. Select "Socket" radio button.
4. Type in IP Address of MLCD.
5. Click "Ping Test" to check status of communication.
6. Close the Communication setup window

• Menu Description

- **Serial** : Set the serial communication as a default communication.
- **Com Port** : Set the port of a PC to communicate with MLCD.
- **Baud Rate** : Fixed at 115200bps.
 - ※ **Caution: Users cannot change the Baud rate.**
- **Socket** : Set the Ethernet LAN communication.
- **Edit Box** : Set the IP address.
- **Port Number** : Fixed as 9761.
 - ※ **Caution: Users cannot change the port number.**
- **Ping Test**: Test the IP address.
- **Connect** : Connect the communication.

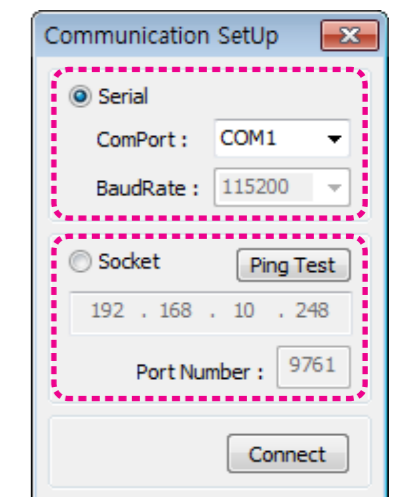

Communication Setup

5.3.3. LAN Port For MLCD

5.3.3.1. In case of connection to a LAN Hub

- This function is used to control the MLCD via LAN PORT.
- * During the setting process, MLCD and control PC should be connected via RS-232C cable only. Do not connect ethernet cable.
- * After setting process, the control PC should be connected to one of MLCD sets with Ethernet cable only. For the connection between the MLCD sets, they should be connected with RS-232C cables.

■ Network IP setting for MLCD

1. Execute the MSCS.
2. Select Com Port and click the "Connect". Click the "Open New Design".

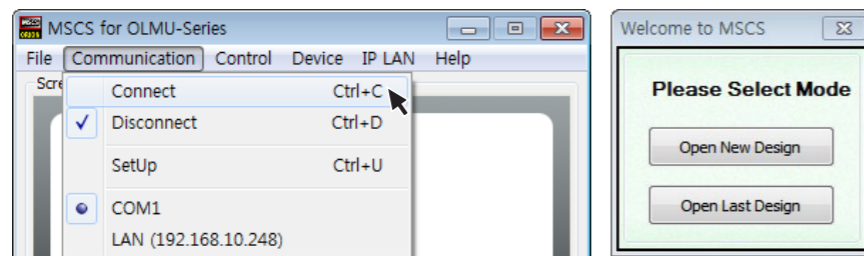

3. Turn on MLCD.
Click the right button of the mouse on the MLCD that you want to control on the screen configuration window.
(This MLCD should be connected to the LAN cable.)

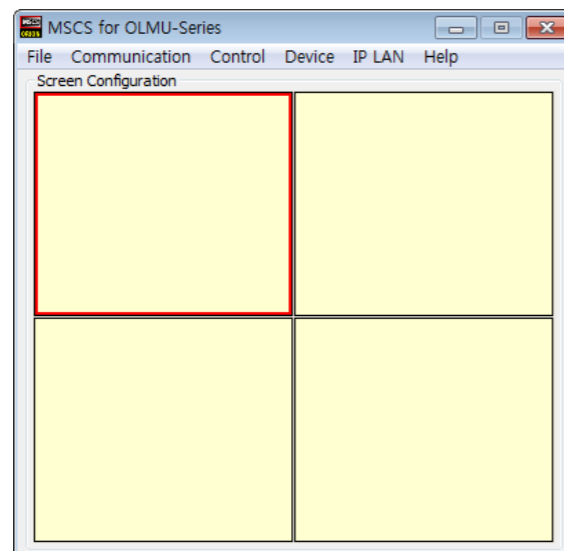

4. Select "IP LAN → IP LAN Configurator or "Ctrl + L" to start Setup.

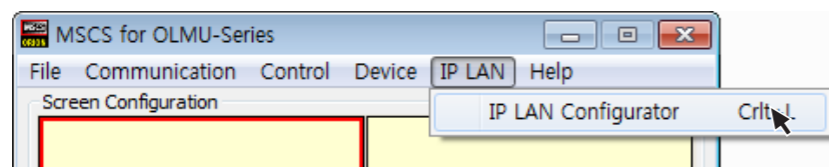

5. Type in the IP address from the network administrator.

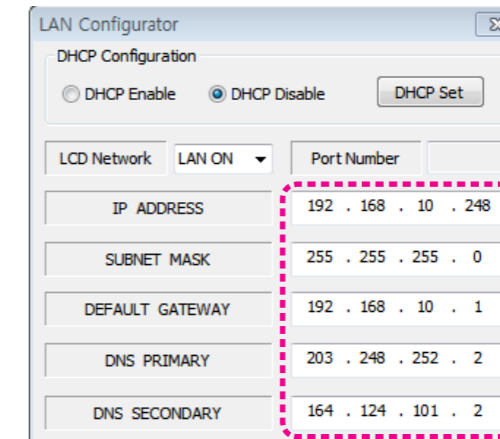

6. Save the IP address by clicking "Set TCP/IP" after type-in.

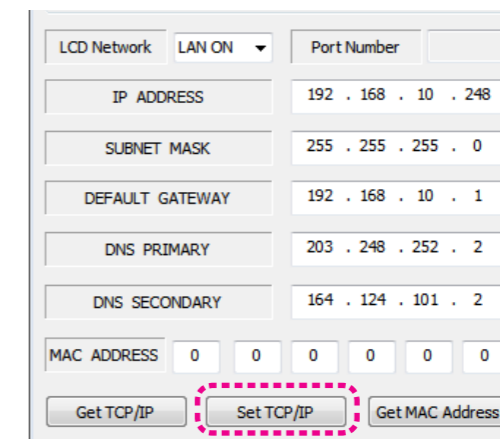

7. Click "Get TCP/IP" and check whether the IP address is correct.

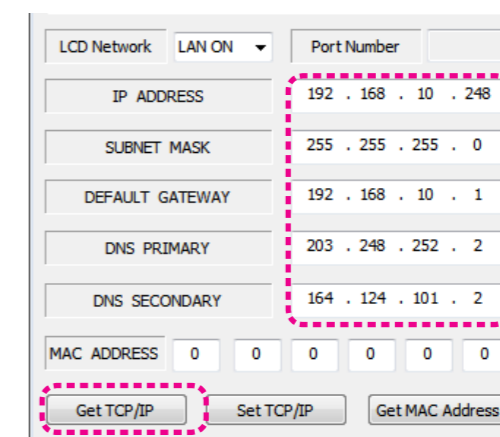

5.3.3.2. In case of connection to user's computer

■ Check the network informations

1. Execute the MSCS.
2. Select Com Port and click the "Connect". Click the "Open New Design".

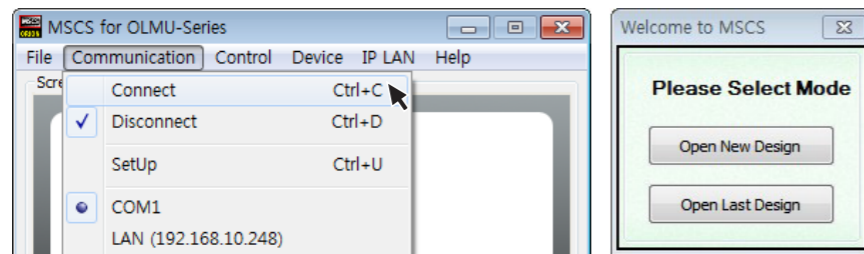

3. Turn on MLCD.
Click the right button of the mouse on the MLCD that you want to control on the screen configuration window.
(This MLCD should be connected to the LAN cable.)

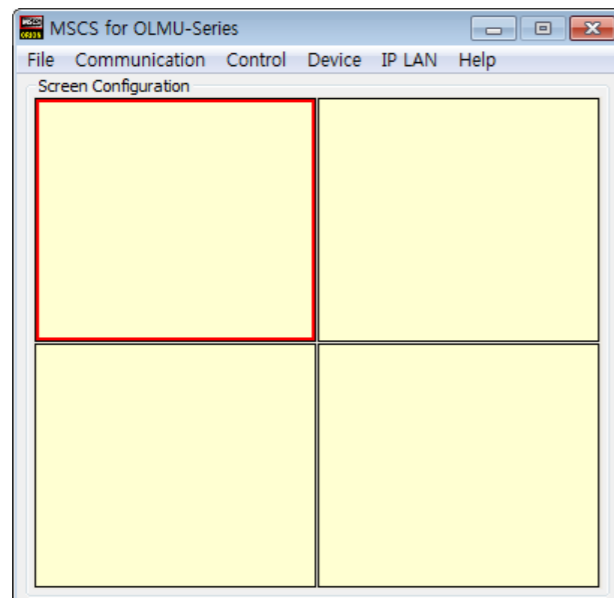

4. Select "IP LAN → IP LAN Configurator" or "Ctrl + L" to start Setup.

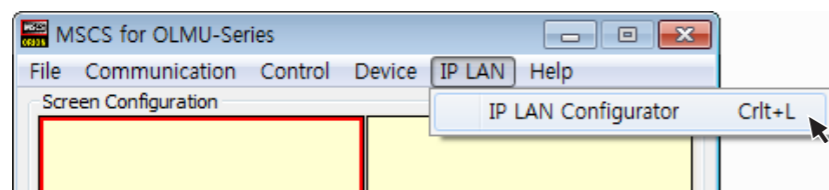

5. Select the "LAN On" and click "Get TCP/IP" to read the initial network configuration of the MLCD.

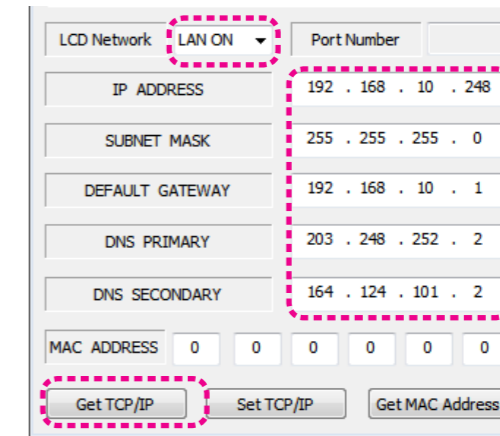

6. Input the network information of the user's PC to be identical with MLCD set.
However, the final digit of the IP address must be different.

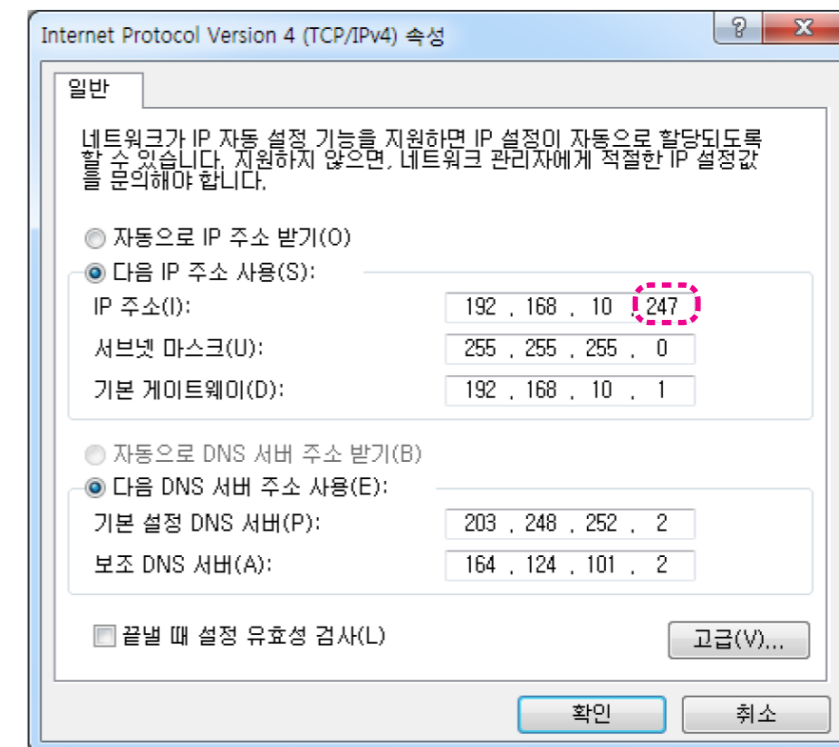

5.4. Design Selection

- You can see following pop-up window for "New design/Last design" when you click "Connect" or press "Ctrl+C" using keyboard after select communication type.



New/Last Design Set

- Click "Open New Design" to prepare new configuration.
- Click "Open Last Design" to go to last design before closing.
- When the connection is successfully completed after setting Com Port, following Message dialog is displayed. The dialog window will be disappeared in 1 second.



- When the connection is successfully completed after setting Lan Port, following Message dialog is displayed. The dialog window will be disappeared in 1 second.



- After Connection, Turn on all of the connected MLCD sets by clicking "Power On" button in Broadcast.

5.5. Screen Configuration

1. Input the numbers of X and Y

- X is for the number of row and Y is for column.
- X and Y can be selected within the range from 1 to 15. The maximum MLCD quantity of MSCS control is 100 sets.
- MLCD image of selected numbers of X and Y is displayed in the Screen configuration in one second after setting the number.

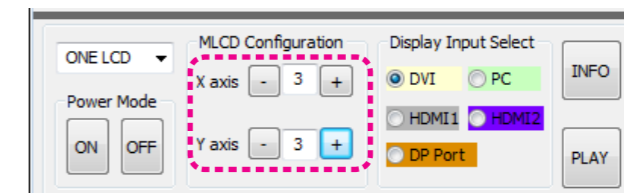

Screen Configuration Setting

2. Select one of input sources from DVI, PC, HDMI1, HDMI2 or DP Port

3. Execution of the configuration.

- When you click "PLAY" button after selecting input source from Source select and the numbers of X and Y in MLCD Configuration, the configuration of MLCD is generated as shown in the figure below.

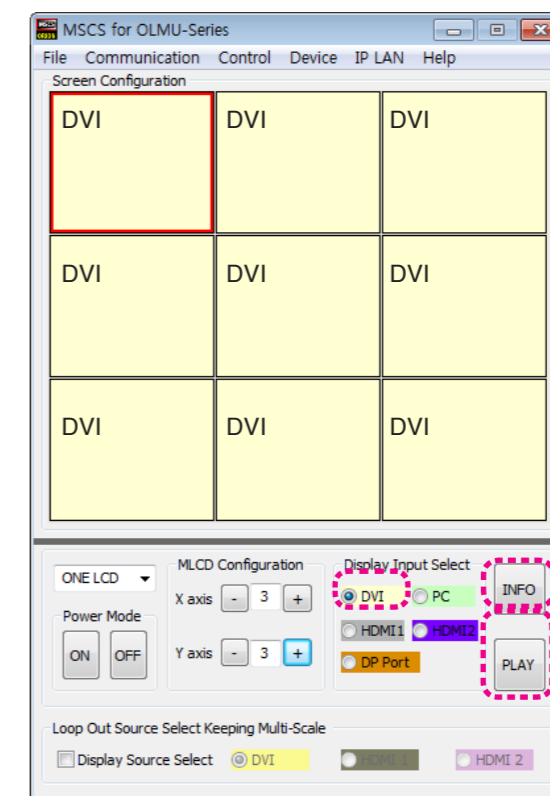

※ INFO :

- Check the resolution of the input source. It is displayed at the upper right corner of the screen.
- Check the signal. If there is no input signal, "No signal" is displayed.

5.6. Selecting the Command transmission method

- **ONE LCD** : Transmit Protocol Command to one MLCD.
- **ALL LCD** : Transmit the Protocol command sequentially to all connected MLCD sets.
- **Broadcast** : Transmit the Protocol command simultaneously to all connected MLCD sets.
- In order to control power of specific MLCD, use "Power On/Off" button after selecting the specific MLCD.

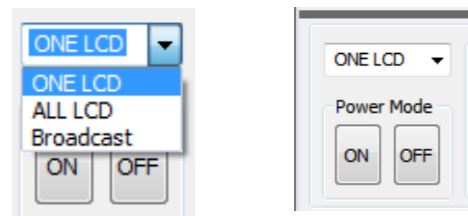

MLCD Control - Power On/Off



- Please wait for at least 10 seconds before executing "Power On" command after the first AC power connection. If not, it may cause abnormal behavior.
- Please disconnect AC power and reconnect in case of abnormal behavior.

5.7. Changing the Input source

- Varieties of screen formations are available with screen configuration.

5.7.1. Click Play button

1. Select the input source at the Display Input Select menu.

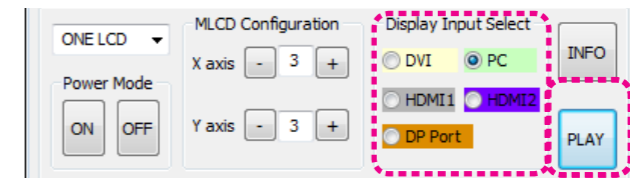

2. The selected input source will be the applied to all LCDs by clicking "Play" button.

- Regardless of the previous setting, the screen configuration will be changed as Individual Screen Mode.

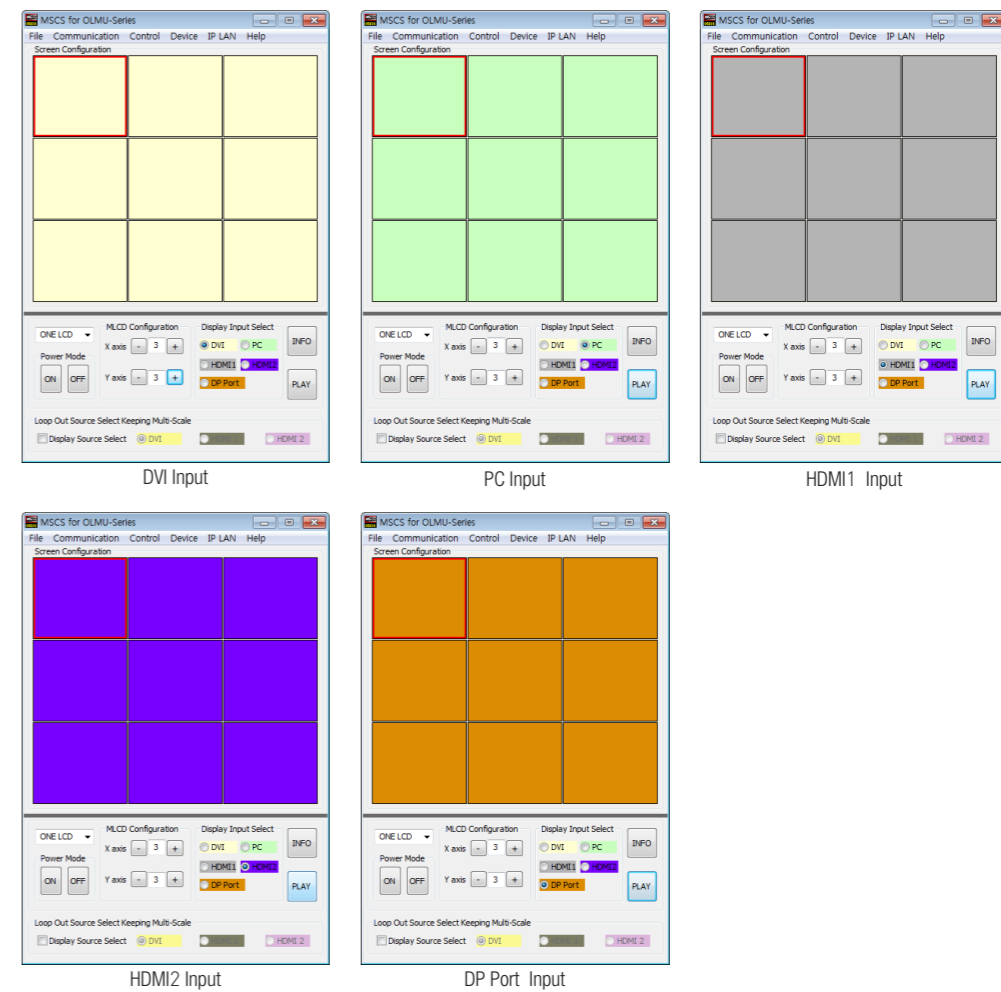

※ Input source is not displayed on the MSCS screen, but it is indicated by colors.

5.7.2. Click the Screen in the Screen Configuration

- To make various Input-screen formation, select an input source and click the screen you want in the Screen configuration with the left button of the mouse.

1. Select the input source at the Display Input Select menu.

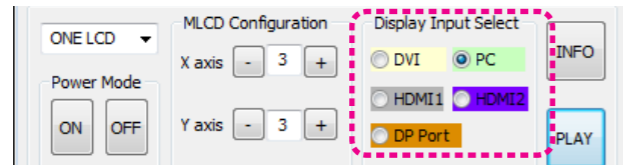

2. Click the screen that you want to change in the Screen Configuration menu with the left button of the mouse.

- DVI screen will be changed with PC.

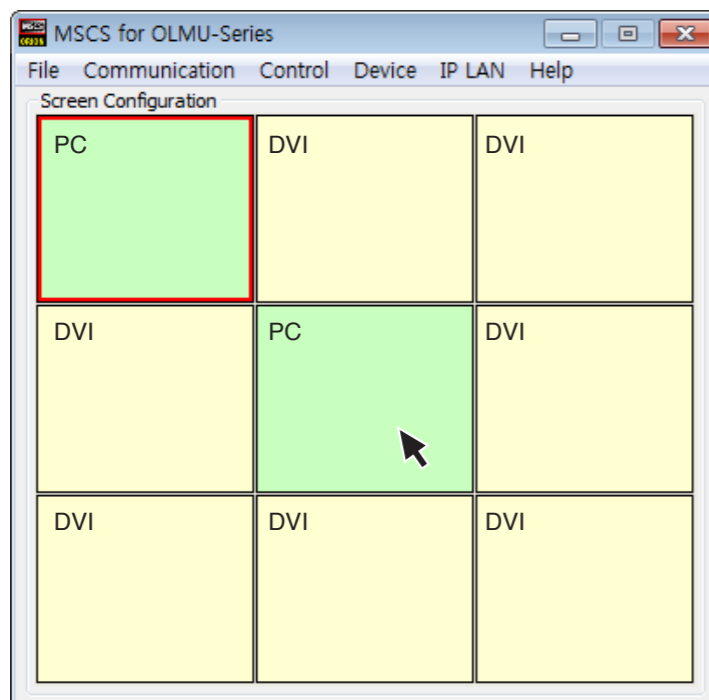

5.7.3. Drag and Drop.

- You can make various multi-screen formations with simple movement.

1. Select an input source at Display Input Select menu.

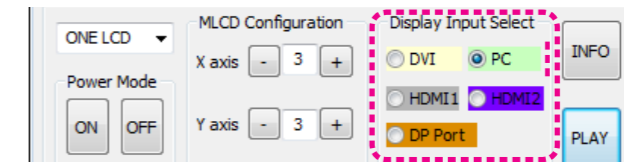

2. Click the screen to change in Screen Configuration with the left button of the mouse and drag.

- Drag from a screen to the screens you want to change.
- All selected screens will be changed to selected input source automatically. (Multi Screen)

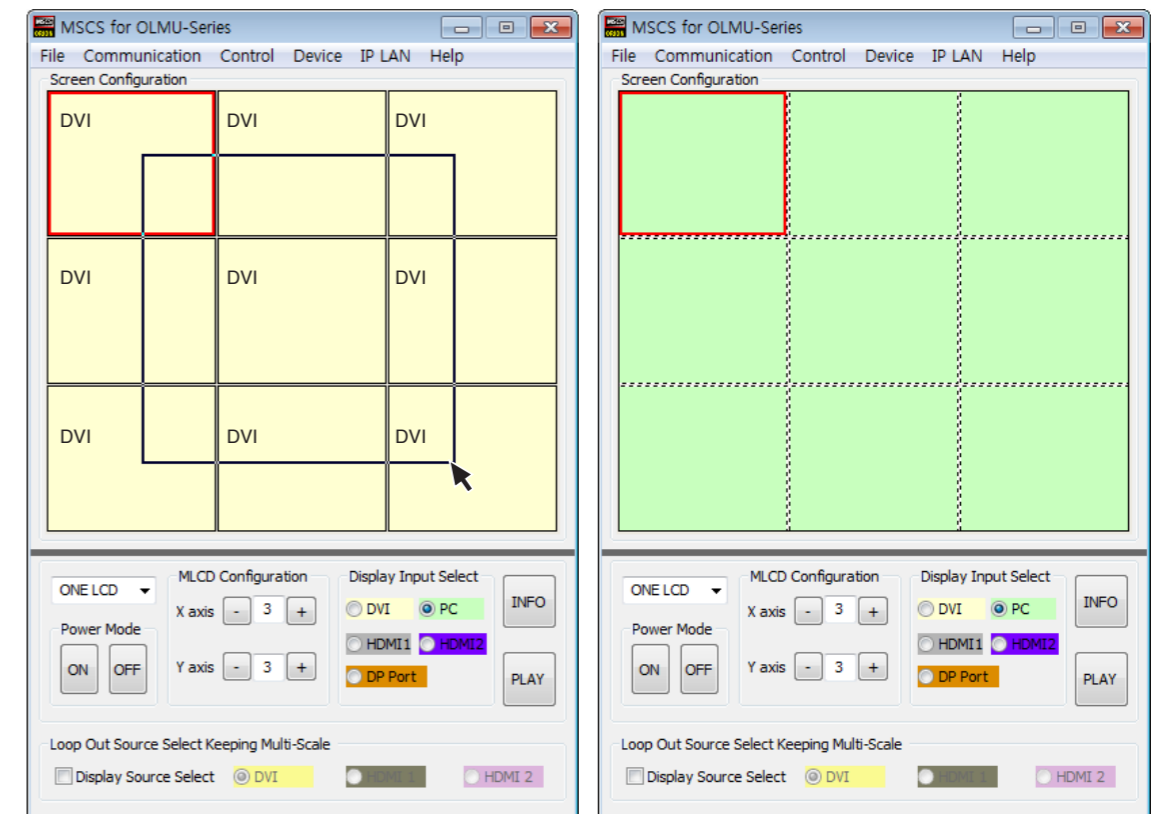

5.8. Displaying the Multi Screen

5.8.1. In case all the sets receive individual video input, respectively.

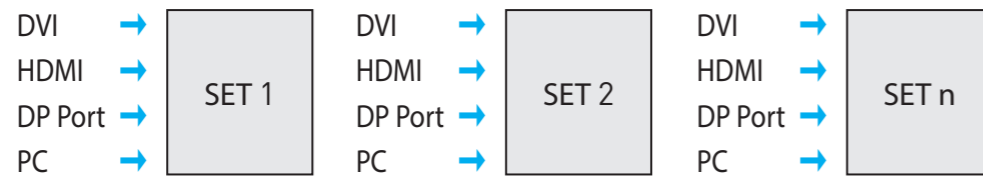

1. Select an input source at Display Input Source menu.

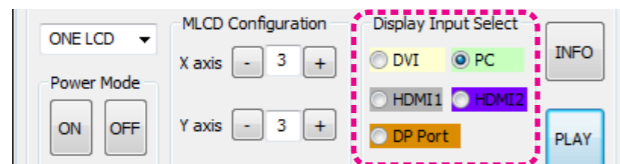

2. Set up the Multi Screen by Drag&Drop

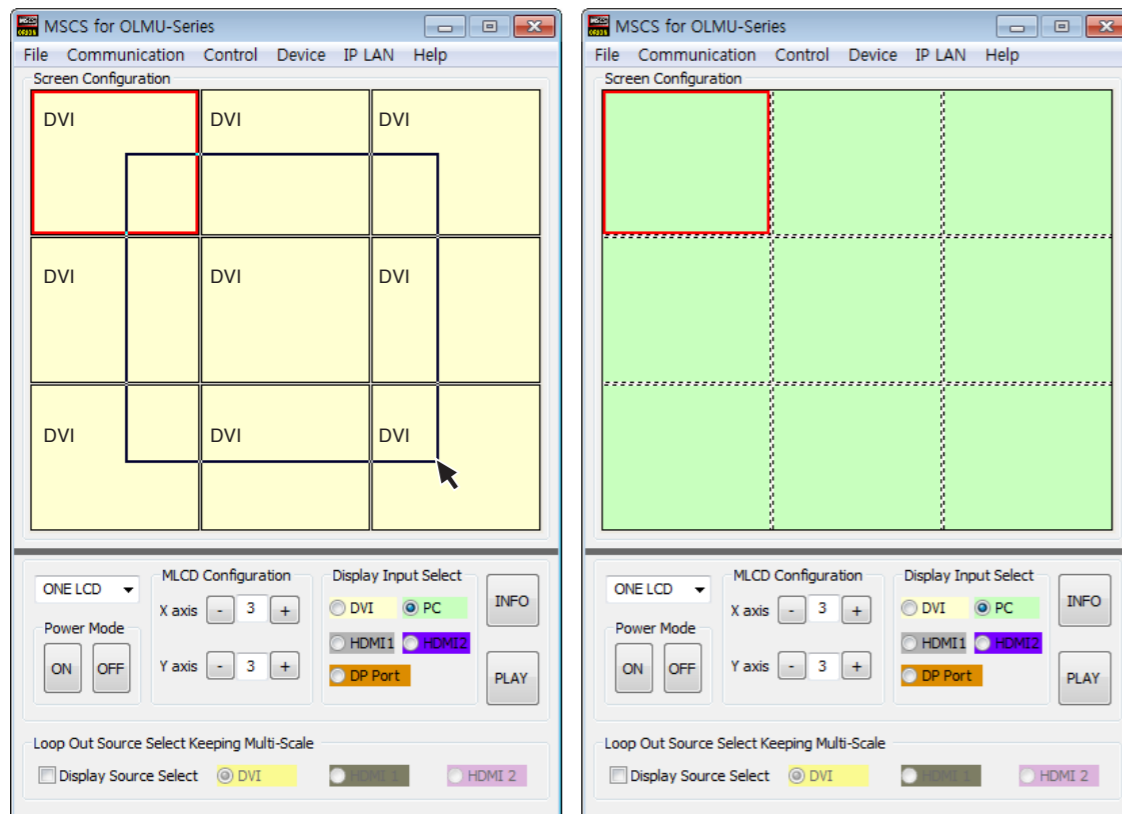

5.8.2. In case all the sets are connected with DVI cables via daisy chain method

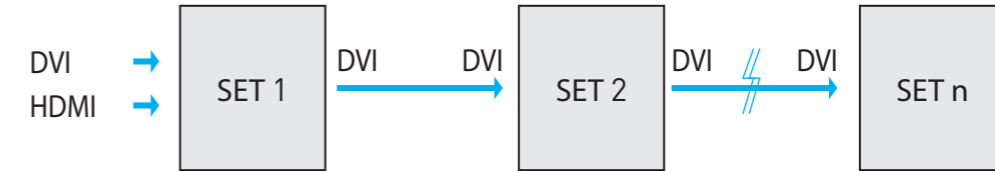

1. Select an DVI at Display Input Source menu.

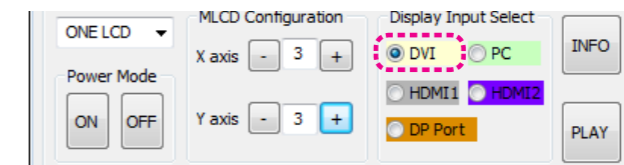

2. Consist Multi Screen by Drag&Drop.

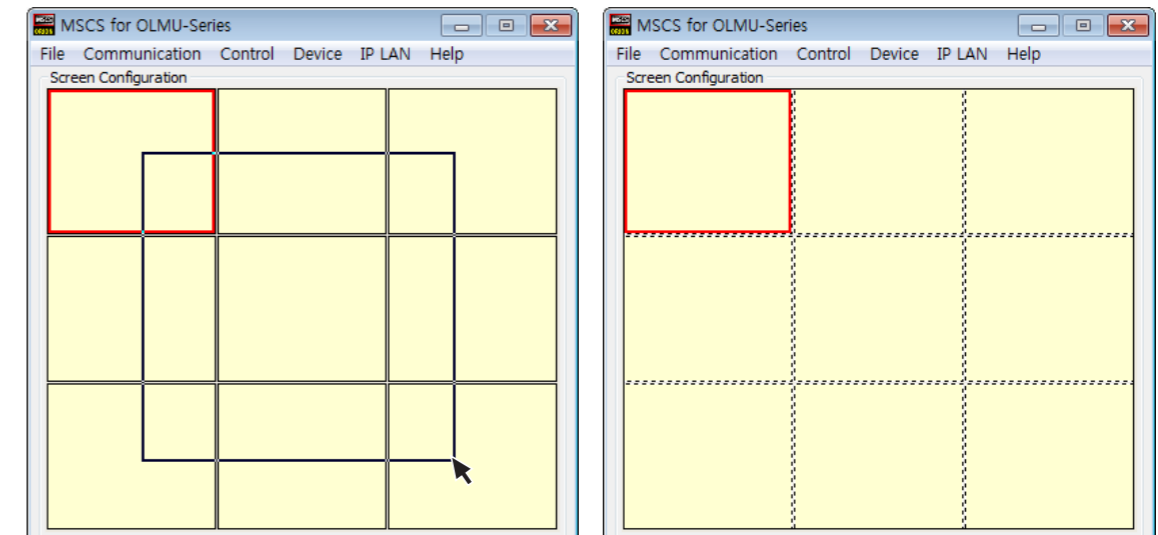

3. Check at "Display Source Select" to change the input source and select an input source

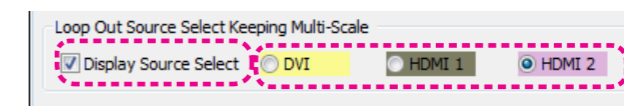

4. click the screen of the first set of daisy chain with the left button of the mouse in Screen Configuration .
 - The input source will be changed without changing currently expanded screen configuration.

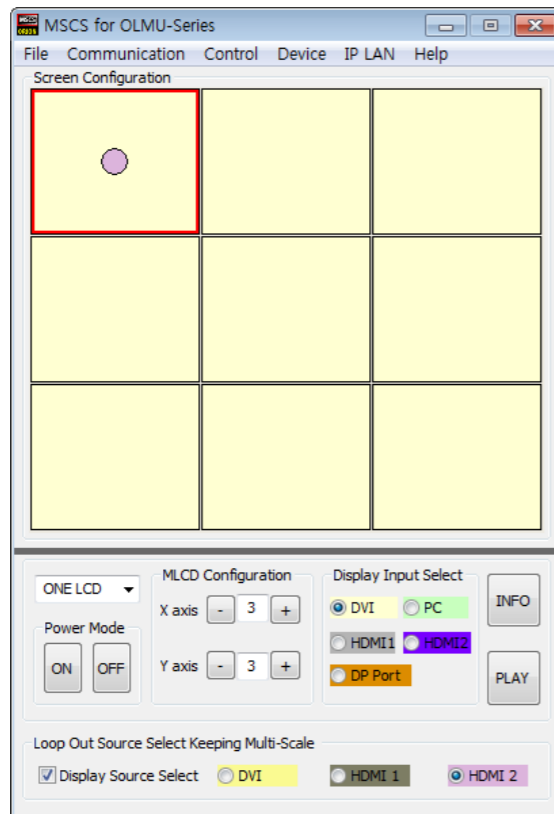

5.9. Control

5.9.1. Slide Control

- MLCD configuration that users can choose is displayed repeatedly.
- To use Slide Control, go to MSCS Menu → Control → Slide Control or press "Ctrl+S" using Keyboard.

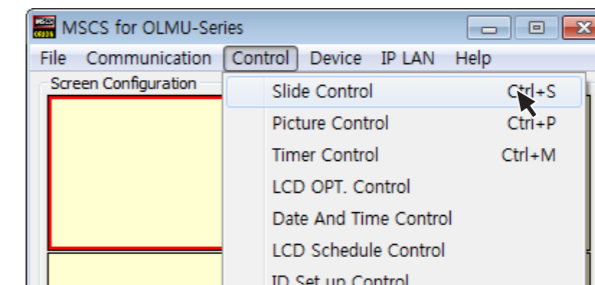

1. Make a desirable configuration in "Screen Configurations"

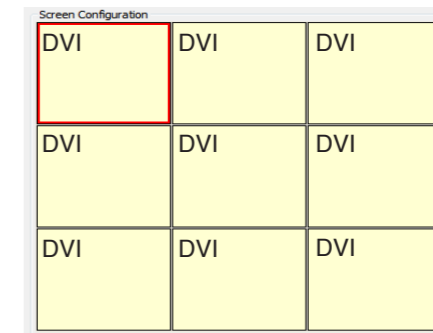
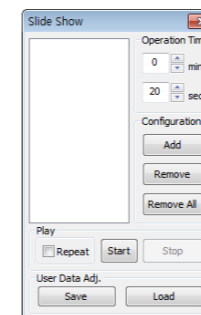

2. Set "Operation Time" in "Slide Control"

- Click "Add" button to save configuration.
- The range of "Operation Time" is from 20 seconds to 1 hour.

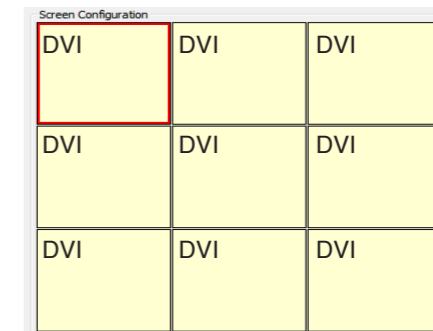
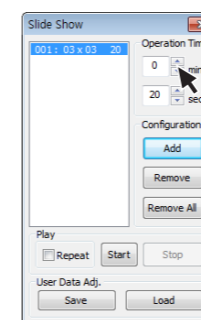

3. Save various screen configurations in the same way.

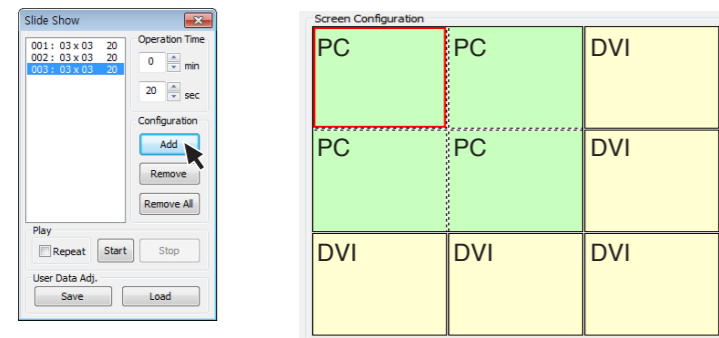

4. Click "Slide Start" to display saved screen configurations.

- Saved screen configurations are displaying for preset time.

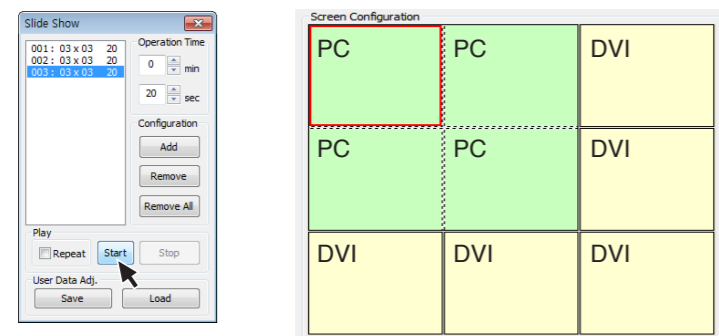

5. Check "Repeat" to display saved configuration repeatedly.

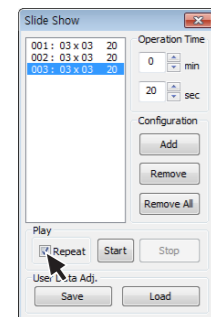

6. Click "Stop" button to end "Slide Control"

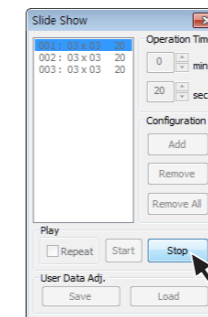

7. Save or Load the slide configuration

- Click "SAVE" button to save user added Slide configuration as "*.ssd" file.
- Click "LOAD" button to open saved "*.ssd" file.

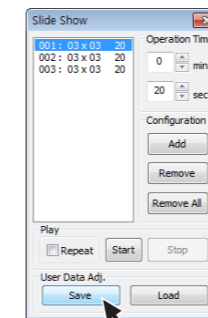

Caution

- When you load "Slide File", previous slide configuration and new slide configuration must be identical.
- If they are different, the file cannot be loaded. So, revise the new slide file configuration as previous configuration or save as new file.

※ To view the saved screen configuration, select the list from "List Box."

※ Saved screen protocol is transmitted to MLCD by double clicking the list.

5.9.2. Picture Control

- Register values related to display of MLCD can be changed.
- To use Picture Control, go to MSCS Menu → Control → Picture Control or press "Ctrl+P" using Keyboard.

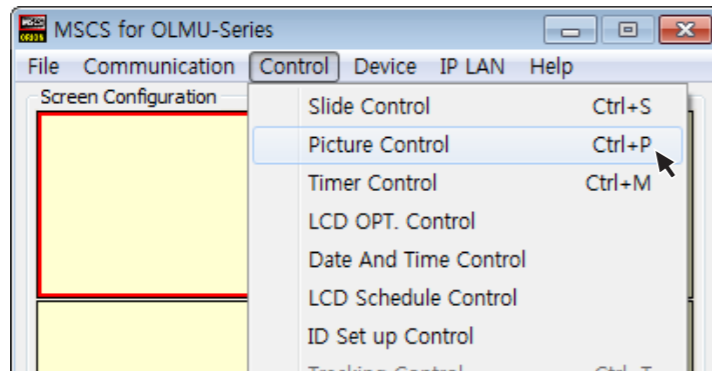

- In order to control display values, input values directly in "Edit Box" and press Enter key. Or click +/- button using mouse.
- Click "Exit" button to close "Picture Control" window.

- **Brightness** : The range of "Brightness" you can adjust is 0 to 100.
- **Contrast** : The range of "Contrast" you can adjust is 0 to 100.
- **Sharpness** : The range of "Sharpness" you can adjust is 0 to 24.
- **Tint** : The range of "Tint" you can adjust is -50 to 50.
- **Color** : The range of "Sharpness" you can adjust is 0 to 100.
- **Dimming** : The range of "Dimming" you can adjust is 0 to 100
- **Color Temp** : Change the color temperature of the screen
-3200K, 6500K, 10000K, User

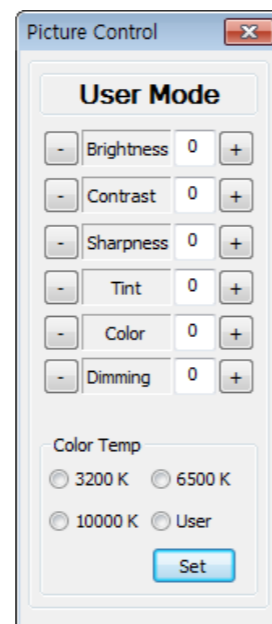

5.9.3. Timer Control

- Users can decide the time of turning on or off MLCD set by timer control.
- To use this function, click Menu → Control → Timer Control or use 'Ctrl +M' keys from the keyboard.

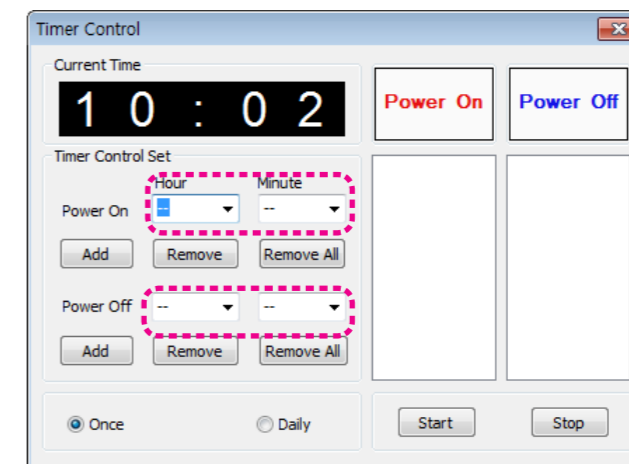
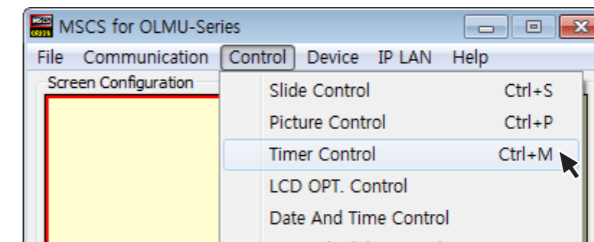

Timer Control Dialog

- How to set the time of power on or off.
 - 1) Select Hour and Minutes of turn on or off
 - 2) After setting Power On/Off time, click "Add" button to add it to Power On/Off List Box. You can save up to 10 settings for Power On/Off. Also, you can delete the saved settings in the List Box one by one with "Remove" button. If you delete all the settings, click "Remove All" button.
 - 3) Select once for one time use and Daily for daily use, then click 'Start'
 - 4) Power on or off signal will be transmitted to MLCD at the time of user set.
- Time Dialog must be activated to use Timer function

5.9.4. Tracking Control

- Alignment adjustment is available when input source is PC.

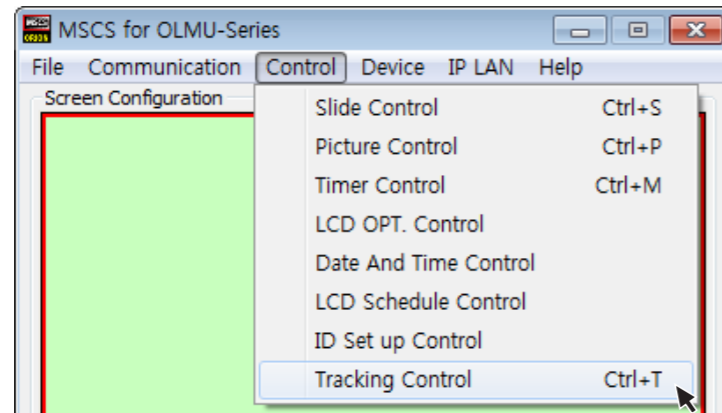

- Go to "Control" in menu bar → Tracking Control or press "Ctrl+T" using keyboard to run "Tracking" window.
- Press "Auto Tracking" button in order to run auto tracking.
- In case alignment doesn't work through "Auto Tracking" command, user can tune finely through "Manual".
- Manual Tracking enables users to set H Position, V Position, Clock and ClockPhase.
- Select panel ID which you want to adjust alignment.
- Detail adjustment steps are as follows.

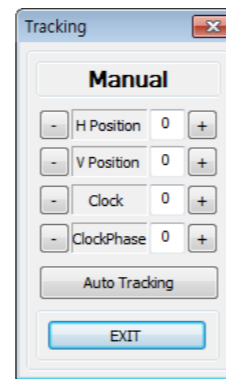

Tracking Manual Window

- 1) Tune "ClockPhase" until the vertical lines are clearly adjusted..
- 2) Tune "V Position" to adjust vertical alignment. "H Position" for horizontal alignment.
- 3) Adjust "Clock" if alignment is still wrong.
If you adjust "Clock", repeat step 1) and 2) to fit alignment.
Adjustable range is as follows
 - The range of "**H Position**" you can adjust is 0 to 100
 - The range of "**V Position**" you can adjust is 0 to 100
 - The range of "**Clock**" you can adjust is 0 to 100
 - The range of "**ClockPhase**" you can adjust is 0 to 63

- Click "EXIT" button to close "Tracking" window.

- ※ When "Tracking" windows is on display, users cannot display "Picture Control" window.
- ※ Even when "Tracking" window is on display, selecting panel ID is available by clicking right button of mouse.

5.9.5. LCD OPT. Control

- Users can configure various additional functions.
- Go to "MSCS Menu" → "Control" → "LCD OPT. Control" to run "LCD OPT Control" window.

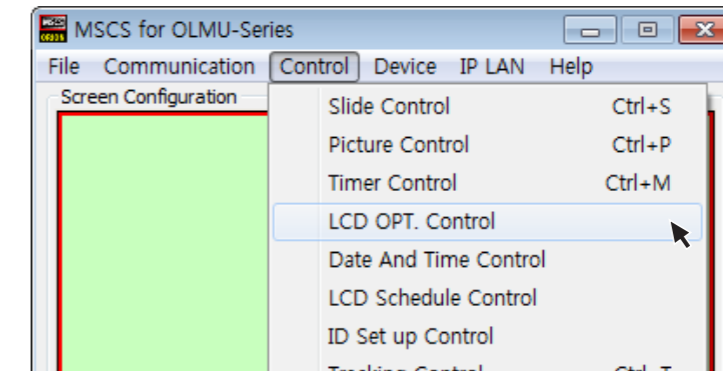

- Power On Delay Time** : This is the configuration command for Turn on delay time after power on.
- Auto Power** : This is the configuration command for automatic power on by AC power connection.
- Color Space** : This is the command for configuring color space of Auto, RGB PC, and RGB Video Mode.
- Fan Control** : This is the command for configuration of Fan.
- Test Pattern Mode** : Display the internal Pattern.
- Frame Compensation** : This is the configuration command for compensating the Frame width.

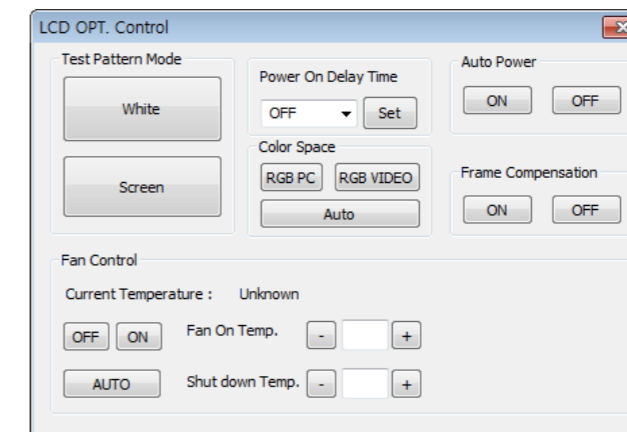

5.9.6. Date and Time Control

- In order to setup to MSCS menu, go to "Control" of menu bar → "Date and Time Control".

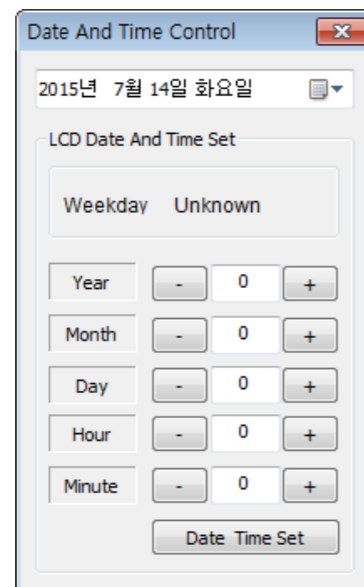
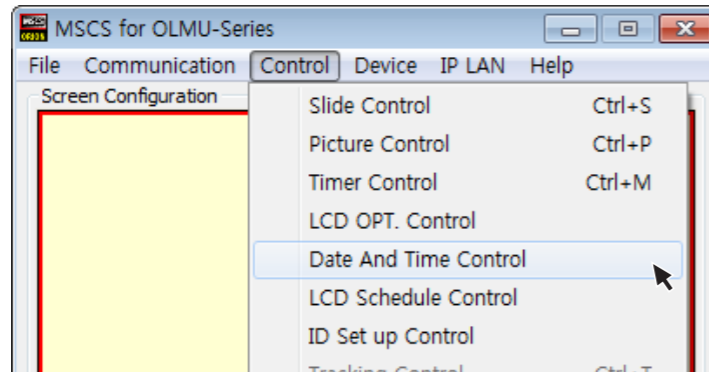

- **Display the date of today.**
- **Year :** This is the command for setting the Year of today.
- **Month :** This is the command for setting the Month of today.
- **Day :** This is the configuration command for setting Day of today.
- **Hour :** This is the command for setting Hour of Current time.
- **Minute :** This is the configuration command for Minute of Current time.
- **Date Time Set :** This is the command to save the setting value.
- This setting value is saved to the inside of monitor.

5.9.7. LCD Schedule Control

- In order to setup to MSCS menu, go to "Control" of menu bar → "LCD Schedule Control".

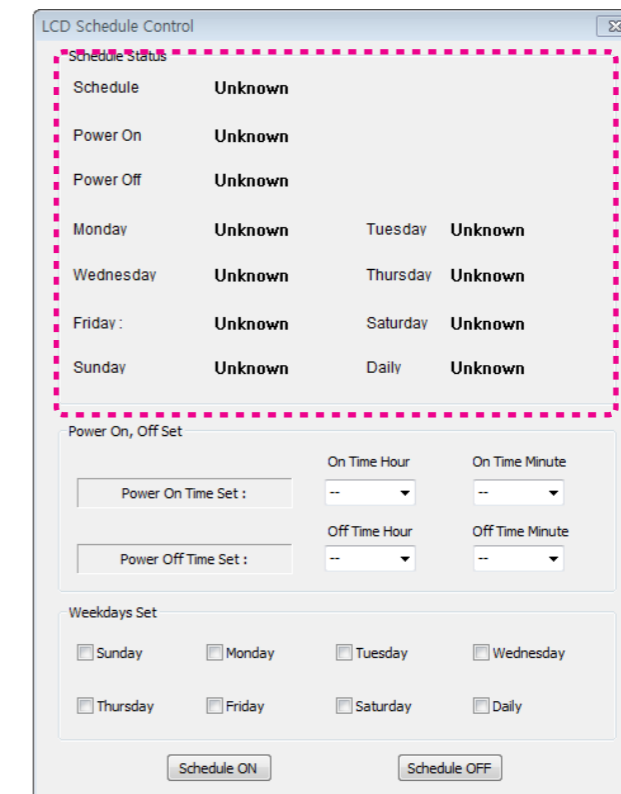
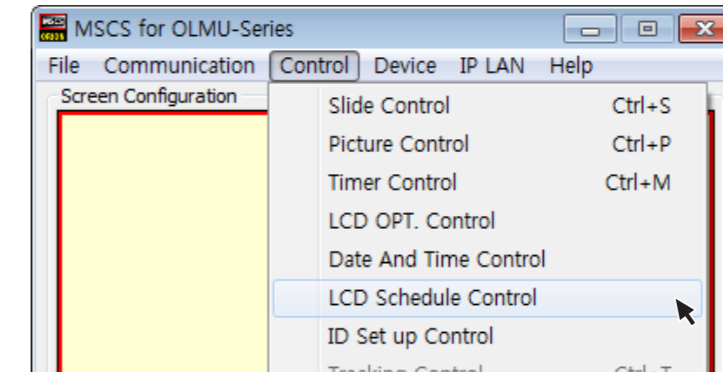

- **Display the current status.**
- **Power On Time Set :** This is the configuration command for a time of automatic power on.
- **Power Off Time Set :** This is the configuration command for a time of automatic power off.
- **Weekdays Set :** This is to set a day of the week on which the command is run.
- **Scheddule ON/Off :** This is the configuration command for the Schedule ON/OFF.

5.10. Help

- In order to move to Orion website, go to "Help" of menu bar "OrionDisplay Home Page"

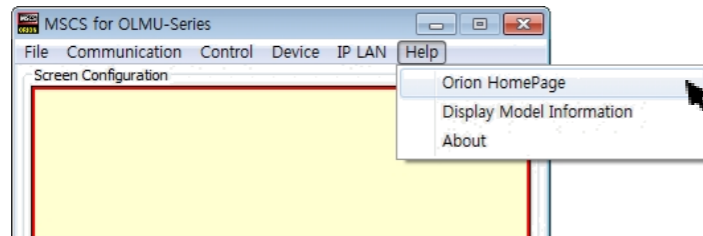

ORION Homepage Log on

- Go to "Help" of menu bar "Display Model Information"

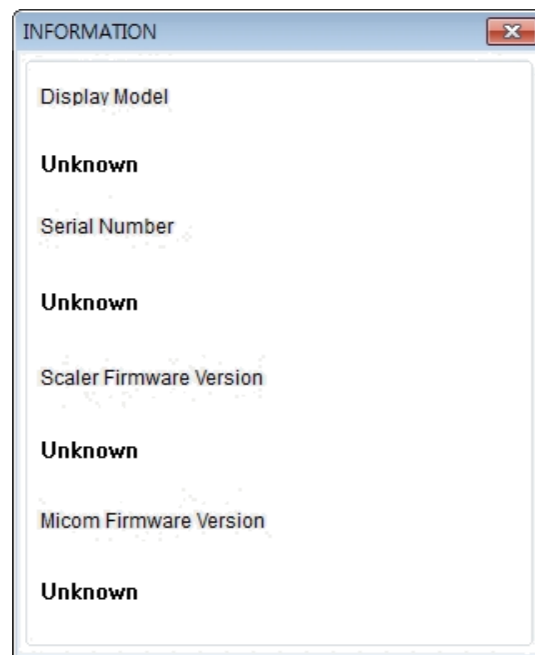

- Go to "Help" of menu bar "About" to check MSCS
If the light leakage is not detected at 1m from the screen, the panel

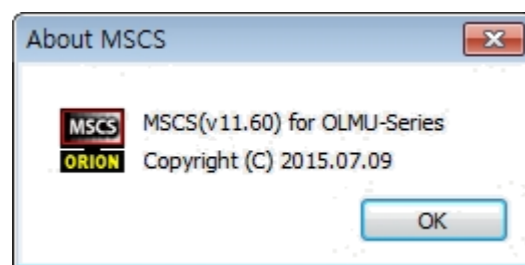

Checking MSCS Version

6. Remote Controller

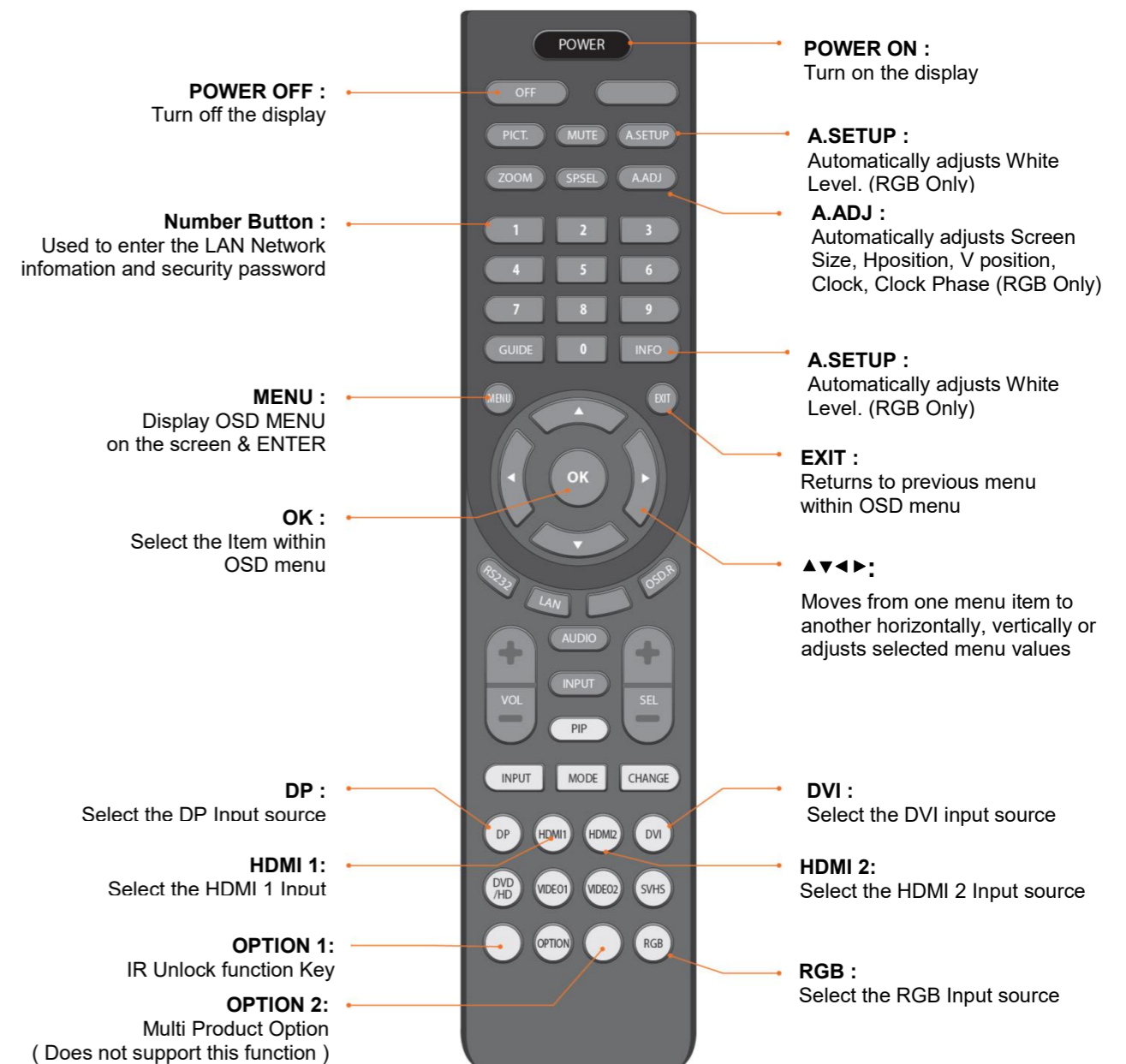

※The button without explanation is not working.

Installing Batteries

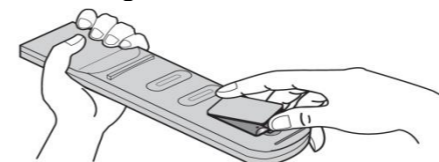

- Open the battery compartment cover on the back side and insert the batteries with correct polarity.
- Install two 1.5V alkaline batteries of AAA type. Don't mix used batteries with new batteries.

6-1. How to use Remote Controller



1. MENU button

- OSD MENU will be displayed by pressing MENU button.
- Moves from sub menu to the main menu.

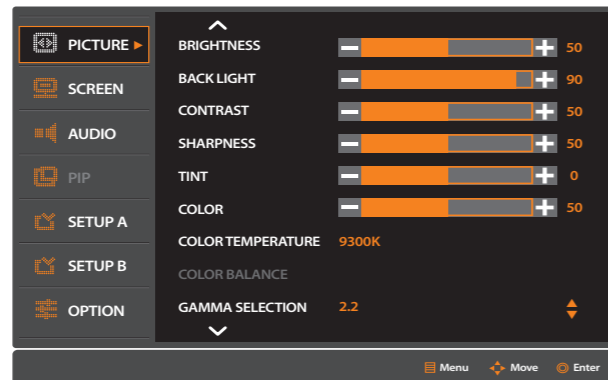

Main Menu

2. Direction buttons & OK Button



- ◀▶ buttons : Select the highlighted items or Moves from one menu item to another horizontally.
- ▼▲ buttons : Acts as button to move the highlighted area up or down to select adjustment items within OSD menu.
- Adjust the selected adjustment item.
- OK button : Select the highlighted item.

3. EXIT button

- Press EXIT button to exit from the MENU after adjustment.

4. INFO button

- The display information for the screen at the moment is displayed at the upper left corner of the screen.
- ex) Input DVI

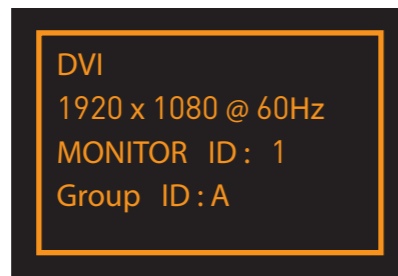

6-2. Configuration

PICTURE Mode

- BRIGHTNESS, CONTRAST, TINT, COROR, VIDEO MODE, and PICTURE RESET can be adjusted in the PICTURE MENU.

1. Press MENU button.

- Press MENU button to display OSD MENU on the screen.

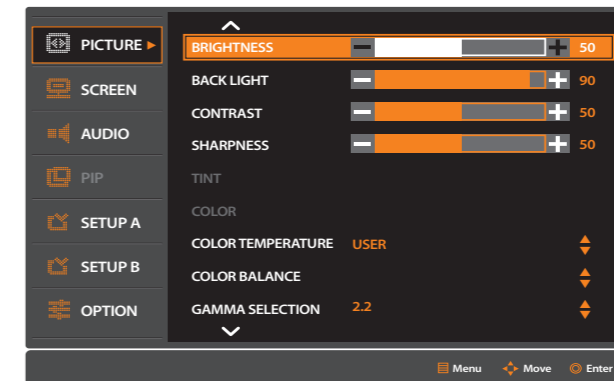

2. Select PICTURE MENU.

- Press ▼ or ▲ buttons to move to PICTURE MENU.
- When PICTURE item is selected, press OK button to move to the picture menu.

3. Select the sub-menu.

- Press ▼ or ▲ buttons to move to sub-menu.
- When sub-menu item is selected, press OK button to adjust the sub-menu.

4. Adjust the value.

- Each of the value can be adjusted by pressing ◀▶ buttons.

5. Exit from the MENU

- Press EXIT button to getting out of OSD MENU.

6. Move to Main MENU

- Press MENU button to move the Main Menu.



▶ BRIGHTNESS

- Adjust the overall image and background brightness.

1. Select BRIGHTNESS from PICTURE Menu.

- Select BRIGHTNESS and move ◀▶ buttons to adjust the value.

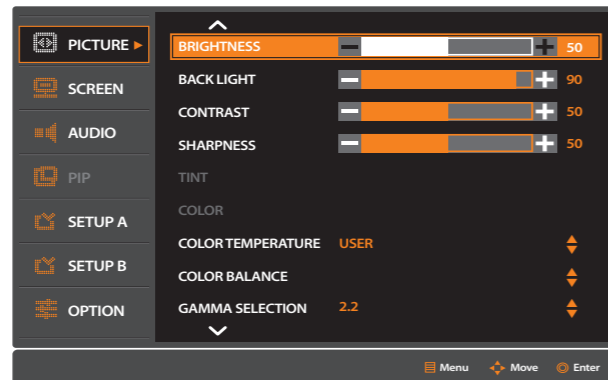

2. EXIT MENU

- Press Exit button to exit from the menu after adjusting the value.

▶ BACK LIGHT

- Adjust the Backlight brightness ca.

1. Select BACK LIGHT from PICTURE Menu.

- Select BACK LIGHT and move ◀▶ buttons to adjust the value.

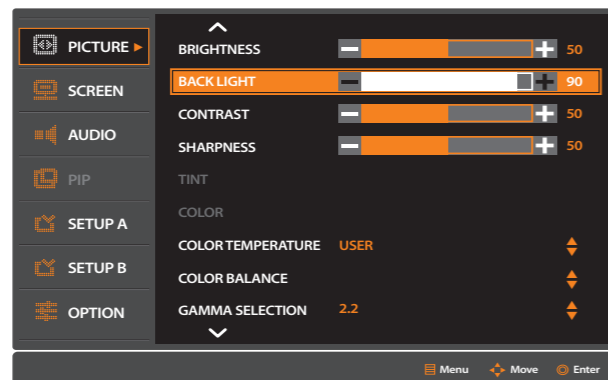

2. EXIT MENU

- Press Exit button to exit from the menu after adjusting the value.

▶ CONTRAST

- Adjust the image brightness in relationship to the background.

1. Select CONTRAST from PICTURE menu.

- Select CONTRAST and move ◀▶ buttons to adjust the value.

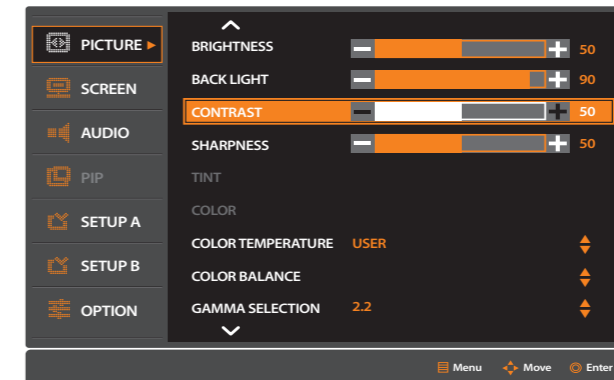

2. EXIT MENU

- Press Exit button to exit from the menu after adjusting the value.

▶ SHARPNESS

- Adjust the crispness of the image.

1. Select SHARPNESS from PICTURE menu.

- Select SHARPNESS and move ◀▶ buttons to adjust the value.

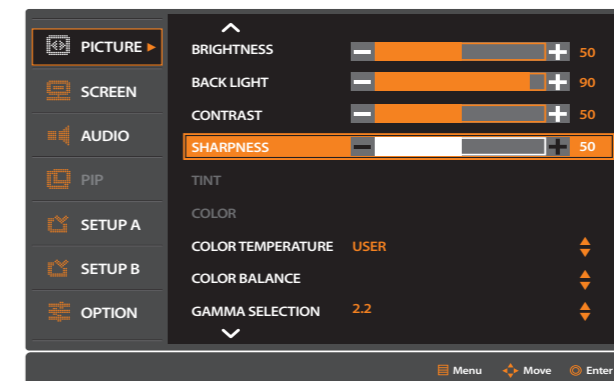

2. EXIT MENU

- Press Exit button to exit from the menu after adjusting the value.

▶ TINT

- Adjust Red and Green color of the screen.

1. Select TINT from PICTURE Menu.

- Select TINT and move ◀▶ buttons to adjust the value.

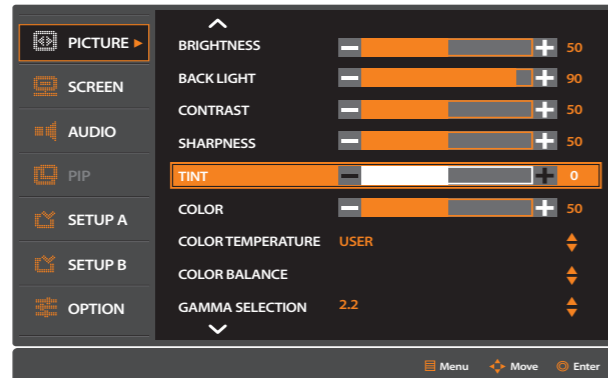

2. EXIT MENU

- Press Exit button to exit from the menu after adjusting the value.

▶ COLOR

- Adjust the depth of the screen color.
- The depth of color will be thicker as the value goes higher.
- As the value goes lower, the depth of color will be getting thinner and go to black and white.

1. Select COLOR from PICTURE Menu.

- Select COLOR and move ◀▶ buttons to adjust the value.

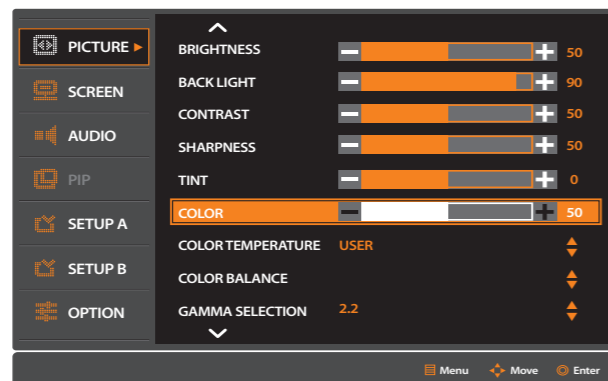

2. EXIT MENU

- Press Exit button to exit from the menu after adjusting the value.

▶ COLOR TEMPERATURE

- Adjust the color temperature of the screen.

1. Select COLOR TEMPERATURE from PICTURE Menu.

- Select COLOR TEMPERATURE.

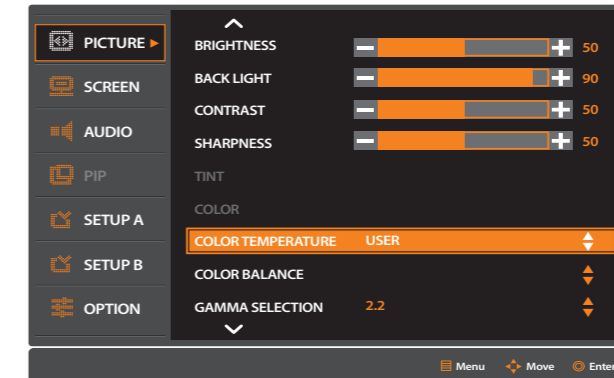

2. Select the desired Color Temperature .

- Select Color Temperature and move ▲▼ buttons to select a Color Temperature of your choice among 3200K, 6500K, 10000K, USER.

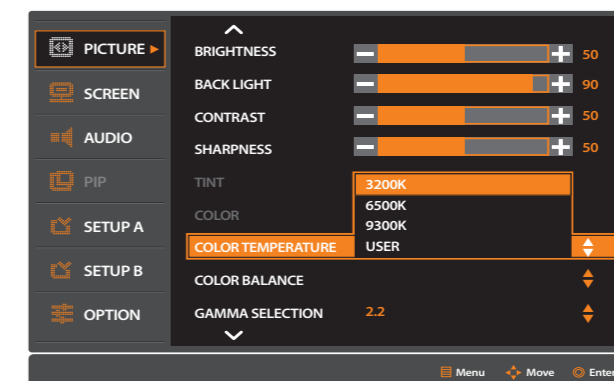

3. EXIT MENU

- Press Exit button to exit from the menu after adjusting the value.

▶ COLOR BALANCE

- If Color TEMPERATURE needs further adjustment, the individual R/G/B levels of the white point can be adjusted. Can be used only in USER MODE of COLOR TEMPERATURE.

1. Select COLOR BALANCE from PICTURE Menu.

- Select COLOR BALANCE.

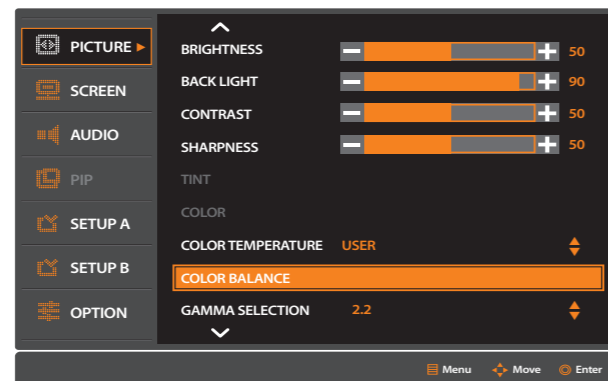

2. Adjust COLOR BALANCE.

- Press ▼ or ▲ buttons to move to Gain-R, Gain-G, Gain-B, Offset-R, Offset-G, Offset-B and move ◀▶ buttons to adjust the value.



3. EXIT MENU

- Press Exit button to exit from the menu after adjusting the value.

▶ GAMMA SELECTION

- Select a display gamma for best picture quality.

1. Select GAMMA SELECTION from PICTURE Menu.

- Select GAMMA SELECTION.

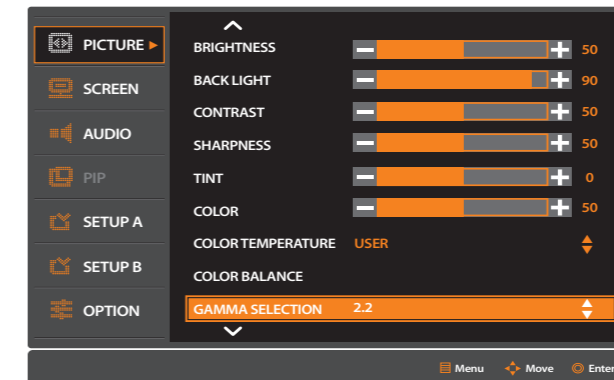

2. Select the 1.8 or 2.2 or DICOM GSDF.

- When highlighted area is moved to wanted adjustment item, press OK button.

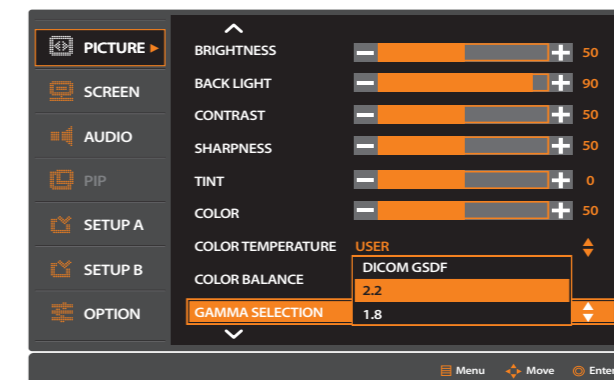

3. EXIT MENU

- Press Exit button to exit from the menu after adjusting the value.

▶ PICTURE RESET

- Initialize the values of PICTURE MENU.

1. Select PICTURE RESET from PICTURE menu.

- Press MENU button to display OSD.
- Press ▼ or ▲ buttons to move to PICTURE RESET and press OK button.

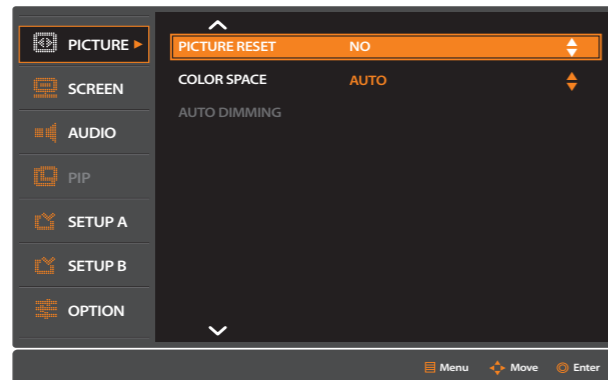

2. Initialize the values

- Select YES or NO for initializing PICTURE RESET menu.
- Press ▼ or ▲ buttons to move to YES and press OK button to initialize the value.

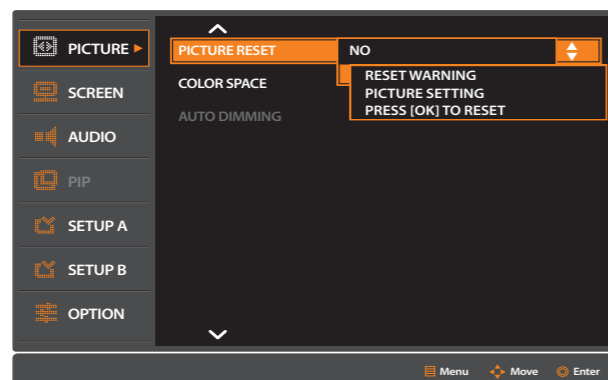
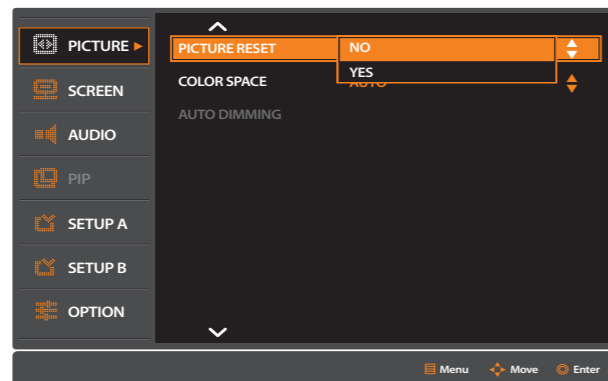

3. EXIT MENU

- Press Exit button to exit from the menu after reset.

▶ COLOR SPACE

- Select a color space for best picture quality.

1. Select COLOR SPACE from PICTURE Menu.

- Select COLOR SPACE.

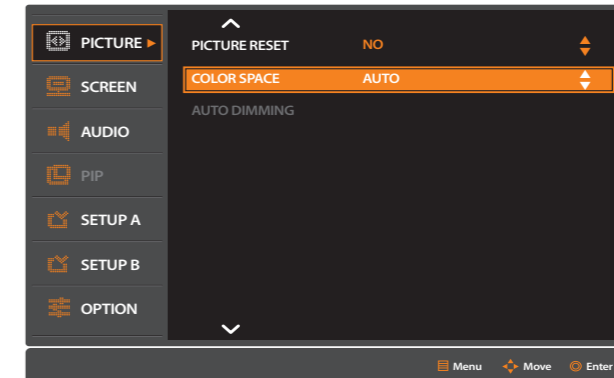

2. Select among the AUTO, RGB PC, RGB VIDEO.

- When highlighted area is moved to wanted adjustment item, press OK button.

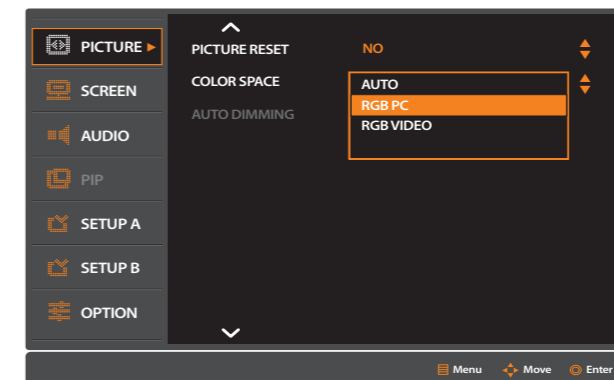

3. EXIT MENU

- Press Exit button to exit from the menu after adjusting the value.

■ SCREEN Mode (For PC In)

- H POSITION, V POSITION, CLOCK, CLOCK PHASE and SCREEN RESET can be adjusted in the SCREEN MENU.



1. Press MENU button.

- Press MENU button to display OSD MENU on the screen.

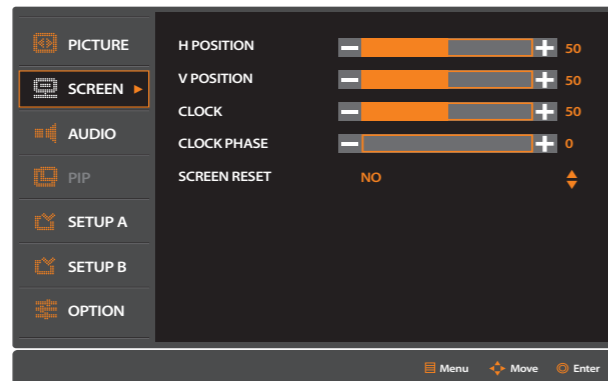

2. Select SCREEN MENU.

- Press ▼ or ▲ buttons to move to SCREEN MENU.
- When SCREEN item is selected, press OK button to move to the screen menu.

3. Select the sub-menu.

- Press ▼ or ▲ buttons to move to sub-menu.
- When sub-menu item is selected, press OK button to adjust the sub-menu.

4. Adjust the value.

- Each of the value can be adjusted by pressing ◀▶ buttons.

5. Exit from the MENU

- Press EXIT button to getting out of OSD MENU.

6. Move to Main MENU

- Press MENU button to move the Main Menu.

▶ H POSITION

- Adjust the horizontal position of the display image on the screen.

1. Select H POSITION from SCREEN menu.

- Adjust H POSITION values with ◀▶ buttons after selecting H POSITION.

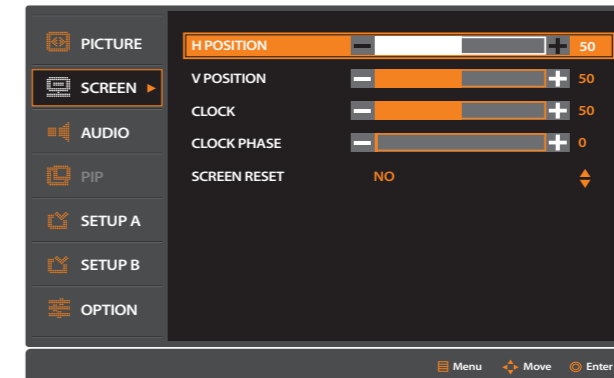

2. EXIT MENU

- Press Exit button to exit from the menu.

▶ V POSITION

- Adjust the vertical position of the display image on the screen.

1. Select V POSITION from SCREEN menu.

- Adjust V POSITION values with ◀▶ buttons after selecting V POSITION.

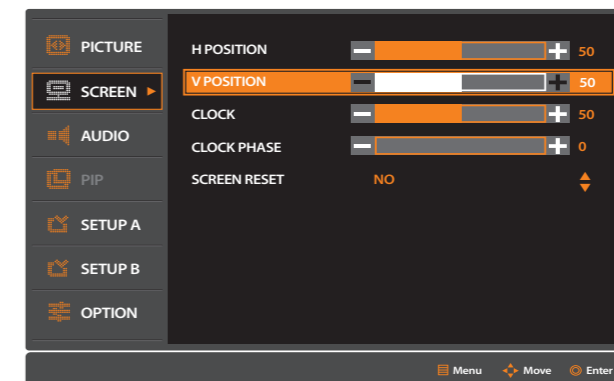

2. EXIT MENU

- Press Exit button to exit from the menu.

▶ CLOCK

- Adjust the width of the display image on the screen.

1. Select CLOCK from SCREEN menu.

- Adjust CLOCK values with ◀▶ buttons after selecting CLOCK.

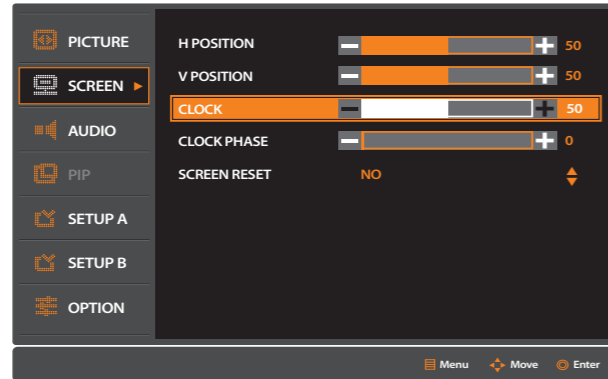

2. EXIT MENU

- Press Exit button to exit from the menu.

▶ CLOCK PHASE

- Adjusts the visual “noise” on the image.

1. Select CLOCK PHASE from SCREEN menu.

- Adjust CLOCK PHASE values with ◀▶ buttons after selecting CLOCK PHASE.

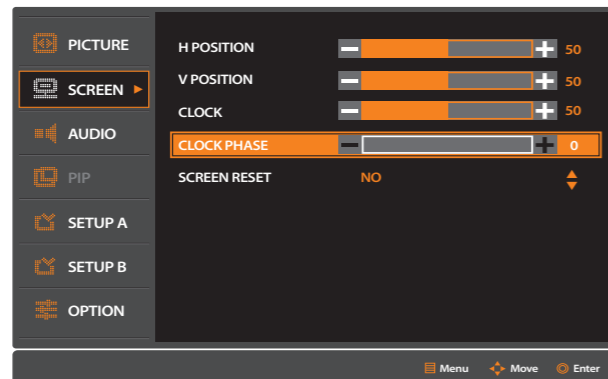

2. EXIT MENU

- Press Exit button to exit from the menu.

▶ SCREEN RESET

- Initialize the values of SCREEN MENU.

1. Select SCREEN RESET from SCREEN menu.

- Press MENU button to display OSD.
- Press ▼ or ▲ buttons to move to SCREEN RESET and press OK button.

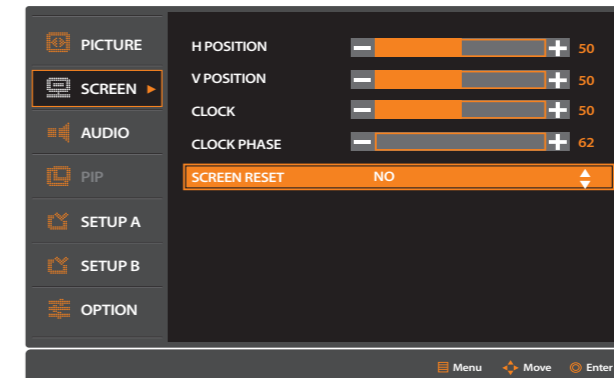

2. Initialize the previously adjusted values.

- Select YES or NO for initializing SCREEN menu.
- Press ▼ or ▲ buttons to move to YES and press OK button to initialize the value.

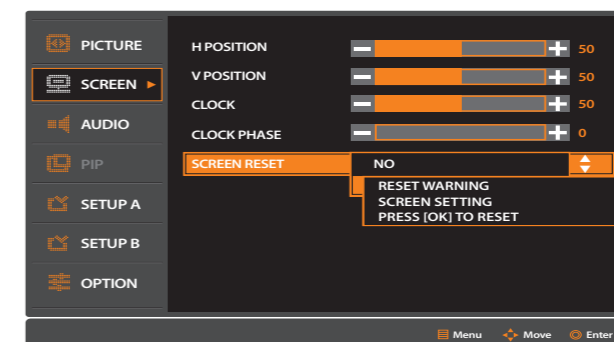
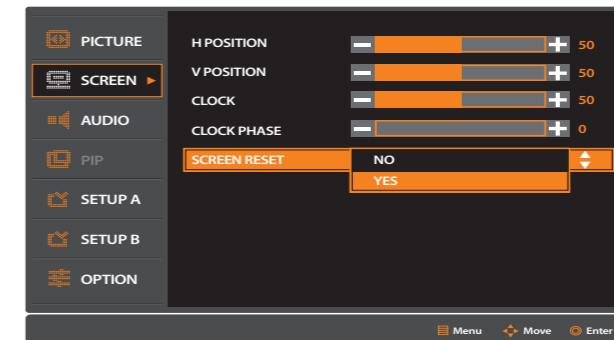

3. EXIT MENU

- Press Exit button to exit from the menu.

■ SETUP A Menu



- AUTO SETUP, AUTO ADJUST, POWER SAVE, AUTO POWER, LANGUAGE, SETUP A RESET and KEY LOCK can be adjusted in SETUP A MENU.

1. Press MENU button.

- Press MENU button to display OSD MENU on the screen.

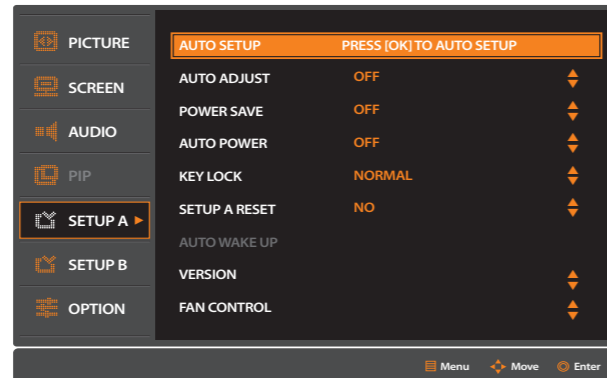

2. Select SETUP A MENU.

- Press ▼ or ▲ buttons to move to SETUP A MENU.
- When SETUP A item is selected, press OK button to move to the SETUP A menu.

3. Select the sub-menu.

- Press ▼ or ▲ buttons to move to sub-menu.
- When sub-menu item is selected, press OK button to adjust the sub-menu.

4. Adjust the value.

- Each of the value can be adjusted by pressing ▼▲ buttons.

5. Exit from the MENU

- Press EXIT button to getting out of OSD MENU.

6. Move to Main MENU

- Press MENU button to move the Main Menu.

▶ AUTO ADJUST (For PC IN)

- Screen Size, H position, V position, Clock, Clock Phase can be adjusted automatically.

1. Select AUTO ADJUST from SETUP A menu .

- Press MENU button to display OSD.
- Press ▼ or ▲ buttons to move to AUTO ADJUST and press OK button.

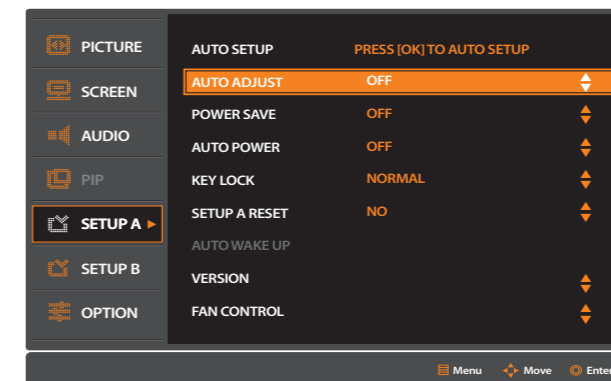

- Select ON or OFF for AUTO ADJUST.
- Press ▼ or ▲ buttons to move to ON and press OK button to adjust automatically.

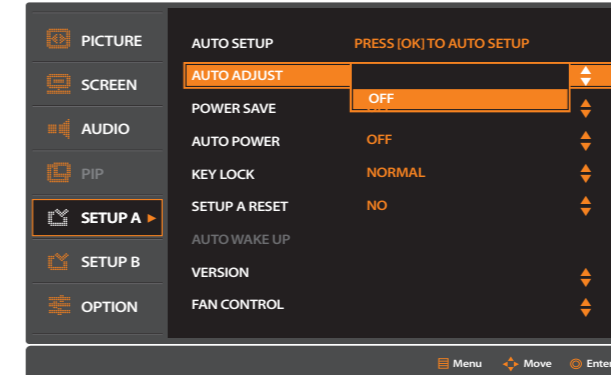

2. EXIT MENU

- Press Exit button to exit from the menu.

▶ POWER SAVE

- The monitor will automatically turn off After settled time when there is no signal.

1. Select POWER SAVE from SETUP A menu .

- Press MENU button to display OSD.
- Press ▼ or ▲ buttons to move to POWER SAVE and press OK button.

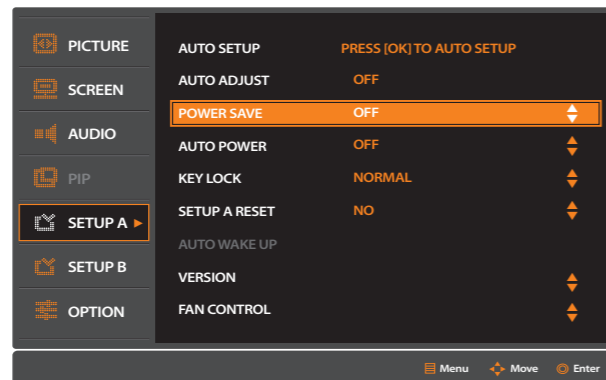

- Press ▼ or ▲ buttons to move to wanted adjustment item, and press OK button.

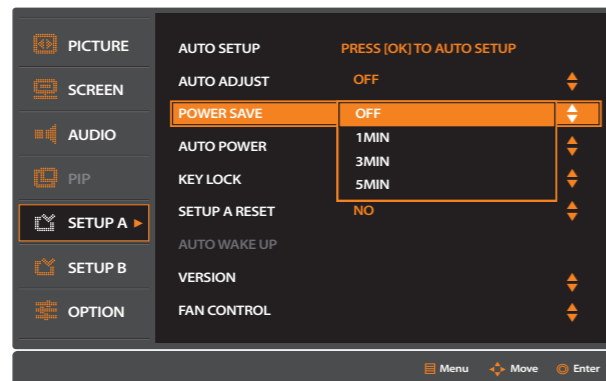

2. EXIT MENU

- Press Exit button to exit from the menu.

▶ AUTO POWER

- The monitor will be turned on automatically when power is connected.

1. Select AUTO POWER from SETUP A menu.

- Press MENU button to display OSD.
- Press ▼ or ▲ buttons to move to AUTO POWER and press OK button.

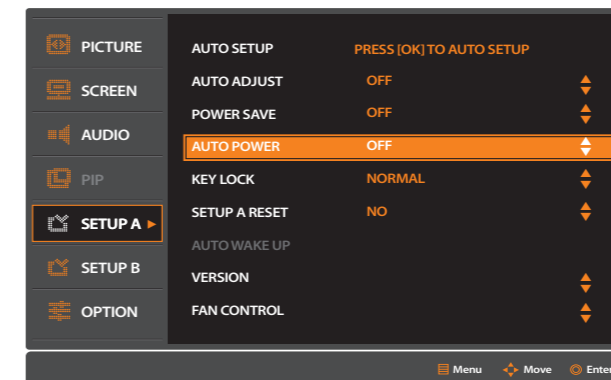

- Select ON or OFF for AUTO POWER.
- Press ▼ or ▲ buttons to move to wanted adjustment item and press OK button.

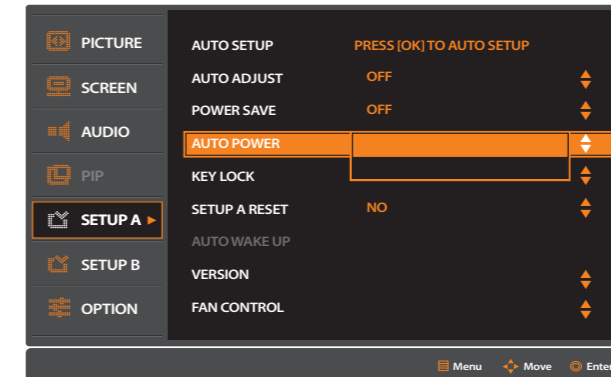

2. EXIT MENU

- Press Exit button to exit from the menu.

▶ KEY LOCK

- Restrict key strokes to prevent any of expected set activities.
To return to normal operation, press the “ENT” button on the KEY PAD for 3 sec.
- LOCK – Key buttons will not work.
- NORMAL – Key buttons will work.

1. Select KEY LOCK from SETUP A menu.

- Press ▼ or ▲ buttons to move to KEY LOCK and press OK button.

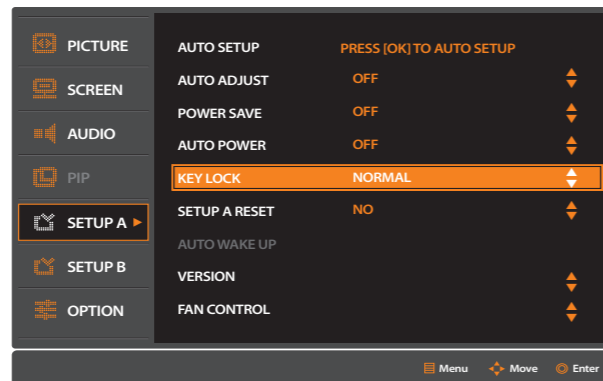

2. Setup the KEY LOCK.

- Press ▼ or ▲ buttons to move to LOCK or NORMAL.
- Move to LOCK and press OK button to activate KEY LOCK.
- To deactivate KEY LOCK, move to NORMAL and press OK button.

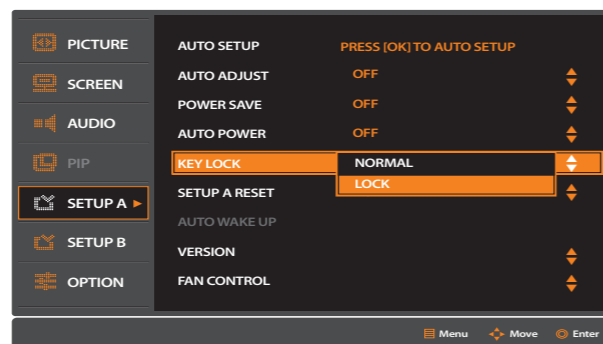

3. EXIT MENU

- Press Exit button to exit from the menu.

▶ SETUP A RESET

- Initialize the values of SETUP A MENU.

1. Select SETUP A RESET from SETUP A menu .

- Press MENU button to display OSD.
- Press ▼ or ▲ buttons to move to SETUP A RESET and press OK button.

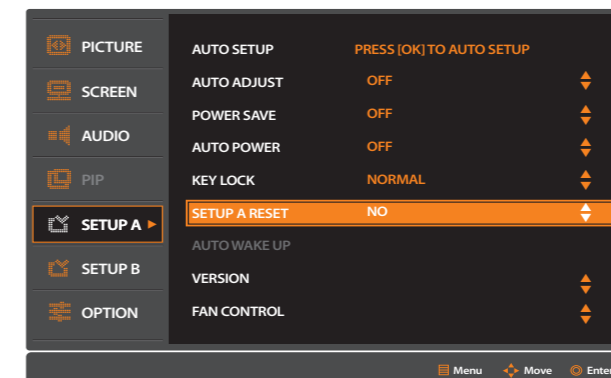

2. Initialize the previously adjusted values.

- Select YES or NO for initializing SETUP A menu.
- Press ▼ or ▲ buttons to move to YES and press OK button to initialize the value.

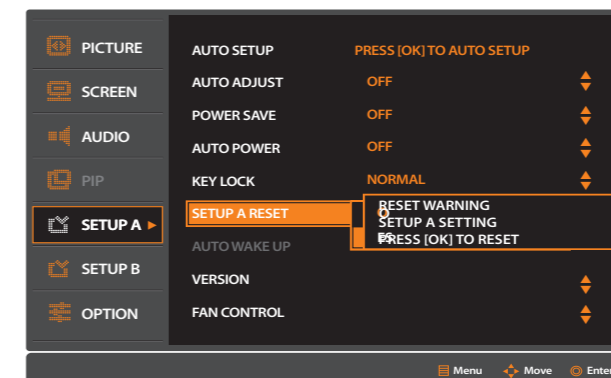

3. EXIT MENU

- Press Exit button to exit from the menu.

▶ VERSION

- Information of Display Firmware Version.

1. Select VERSION from SETUP A menu .

- Press MENU button to display OSD.
- Press ▼ or ▲ buttons to move to VERSION and press OK button.

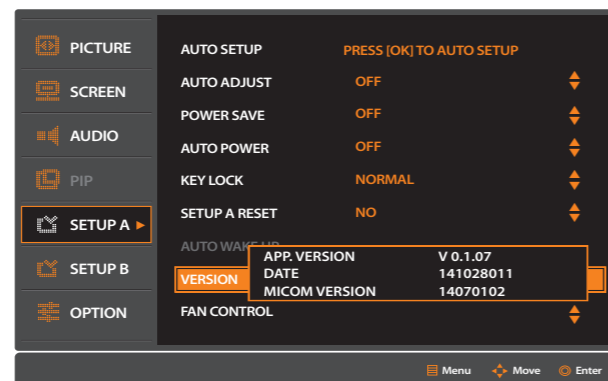
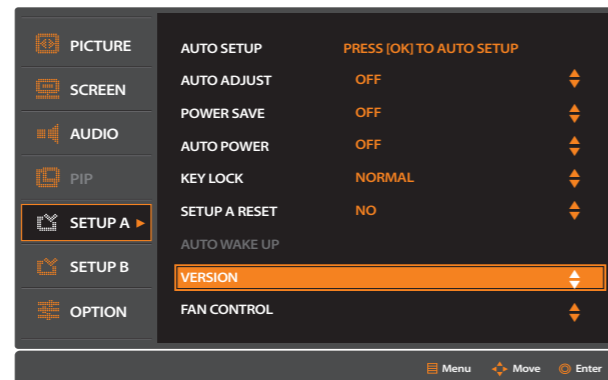

2. EXIT MENU

- Press Exit button to exit from the menu.

■ SETUP B

- SERIAL CONTROL, LAN SETTING, OSD, OFF TIMER, SETUP B RESET and DEFAULT SETTING can be adjusted in SETUP B MENU.

1. Press MENU button.

- Press MENU button to display OSD MENU on the screen.

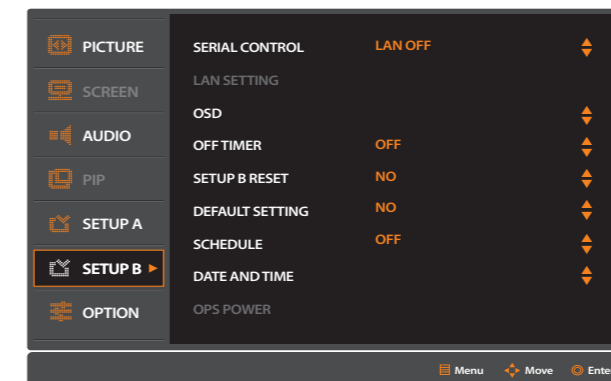

2. Select SETUP B MENU.

- Press ▼ or ▲ buttons to move to SETUP B MENU.
- When SETUP B item is selected, press OK button to move to the SETUP B menu.

3. Select the sub-menu.

- Press ▼ or ▲ buttons to move to sub-menu.
- When sub-menu item is selected, press OK button to adjust the sub-menu.

4. Adjust the value.

- Each of the value can be adjusted by pressing ▼▲ buttons.

5. Exit from the MENU

- Press EXIT button to getting out of OSD MENU.

6. Move to Main MENU

- Press MENU button to move the Main Menu.



▶ SERIAL CONTROL

- Select the LAN On or LAN Off.

1. Select SERIAL CONTROL from SETUP B menu.

- Press MENU button to display OSD.
- Press ▼ or ▲ buttons to move to SERIAL CONTROL and press OK button.

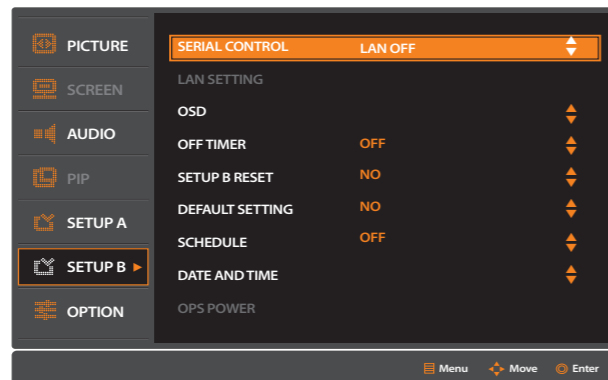

2. Select LAN ON or LAN Off.

- Press ▼ or ▲ buttons to Select LAN ON or OFF and press OK button.

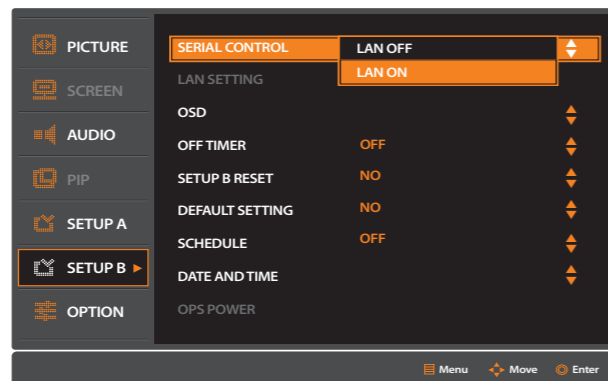

3. EXIT MENU

- Press Exit button to exit from the menu.

▶ LAN SETTING

- Configure the IP address of the set to control via Ethernet.

1. Select LAN SETTING from SETUP B menu.

- Press MENU button to display OSD.
- Press ▼ or ▲ buttons to move to LAN SETTING and press OK button.

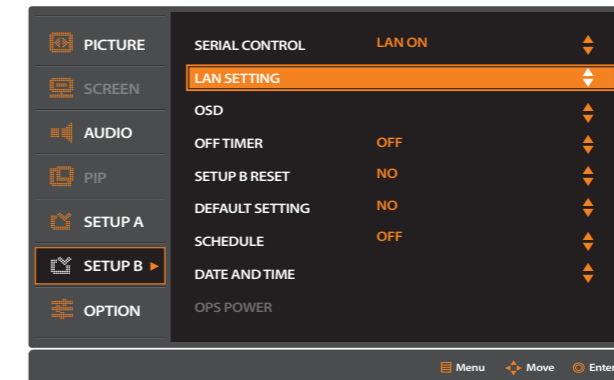

2. Setup the LAN Port information.

- Enter the network information by number buttons.

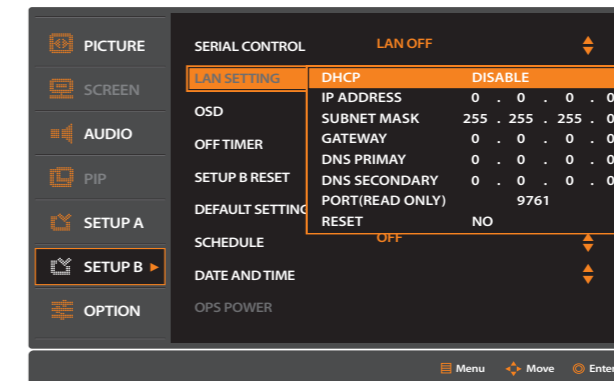

3. EXIT MENU

- Press Exit button to exit from the menu.

▶ OSD

- It configures OSD menu.

1. Select OSD from SETUP B menu.

- Press MENU button to display OSD.
- Press ▼ or ▲ buttons to move to OSD and press OK button.

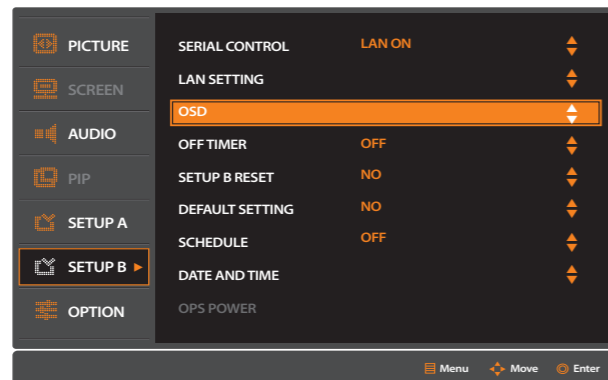

2. Setup the function.

- Press ▼ or ▲ buttons to move to item and press OK button.

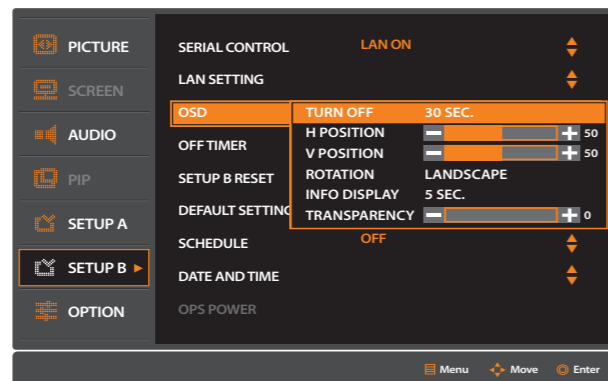

3. EXIT MENU

- Press Exit button to exit from the menu.

» TURN OFF

- Turns off the OSD after a period of inactivity. The preset choices are 5-120 seconds.

1. Select TURN OFF.

- Press ▼ or ▲ buttons to move to TURN OFF and press OK button.

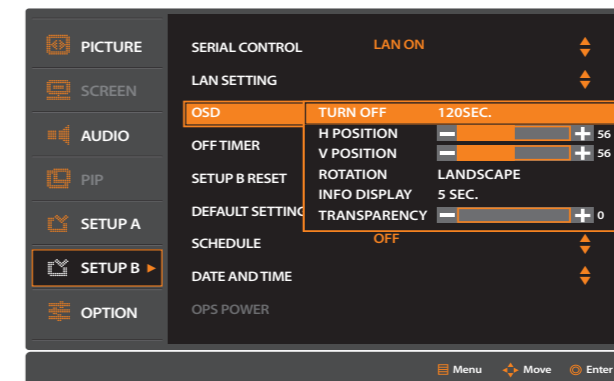

2. Setup the turn off time.

- Press ▼ or ▲ buttons to adjust OSD Turn Off time and press OK button.

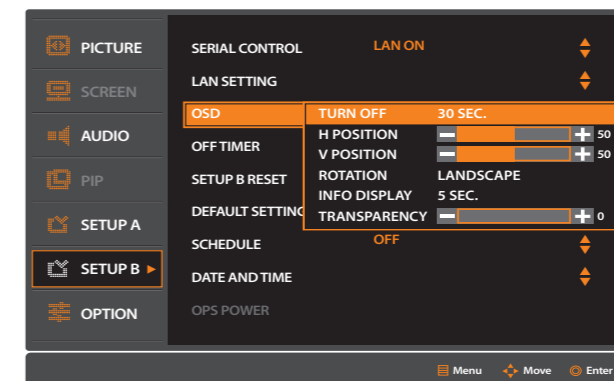

3. EXIT MENU

- Press Exit button to exit from the menu.

» POSITION

- Select the location where the OSD appears on the screen.

1. Select OSD H POSITION

- Press ▼ or ▲ buttons to move to H POSITION and press OK button.
- Adjust OSD H POSITION values with ◀▶ buttons after selecting H POSITION.

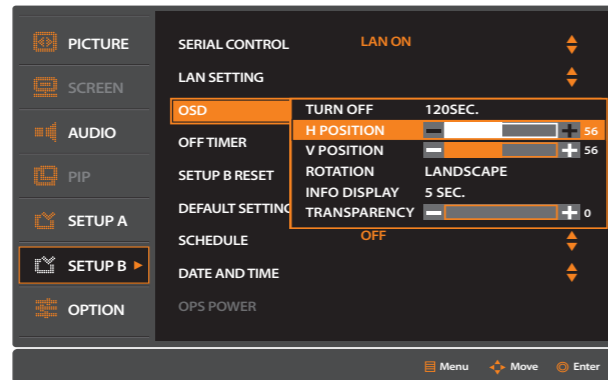

2. Select OSD V POSITION

- Press ▼ or ▲ buttons to move to V POSITION and press OK button.
- Adjust OSD V POSITION values with ◀▶ buttons after selecting V POSITION.

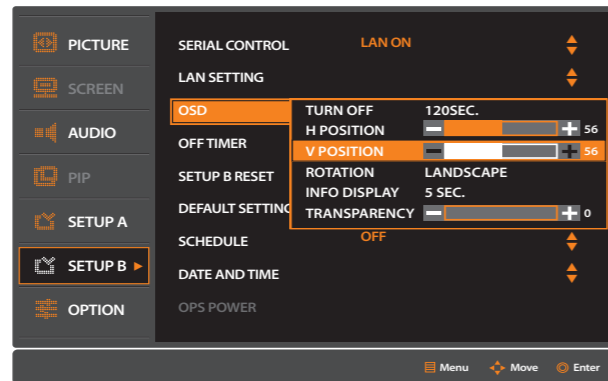

3. EXIT MENU

- Press Exit button to exit from the menu.

» ROTATION

- Select the OSD display direction between landscape and portrait.

1. Select ROTATION from OSD menu.

- Press ▼ or ▲ buttons to move to ROTATION and press OK button.

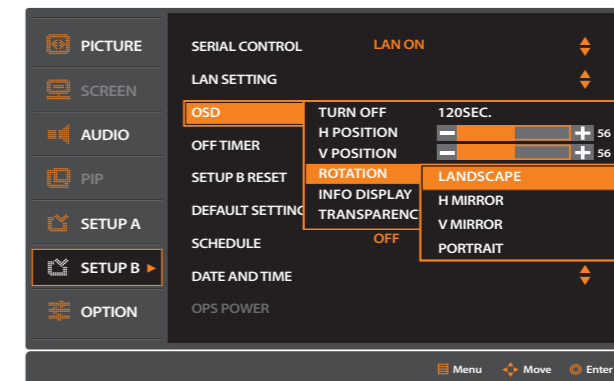

2. Setup the ROTATION.

- Press ▼ or ▲ buttons to move to item and press OK button.

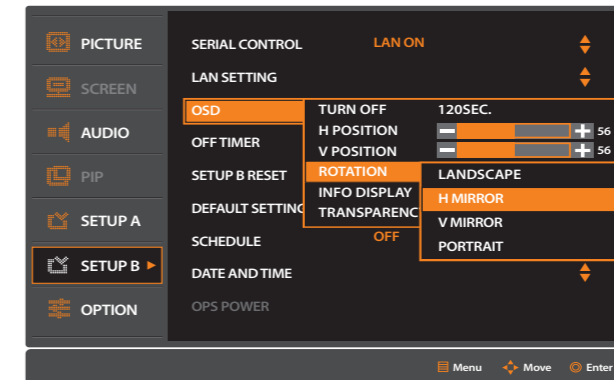

3. EXIT MENU

- Press Exit button to exit from the menu.

» INFO DISPLAY

- Select to display or not display the information OSD. The information OSD will be displayed when the input signal or source are changed. The information OSD will also give a warning when there is no-signal or the signal is out-of range.
An display interval for the information OSD can be selected between 3 to 10 seconds.

1. Select INFO DISPLAY from OSD menu.

- Press ▼ or ▲ buttons to move to INFO DISPLAY and press OK button.

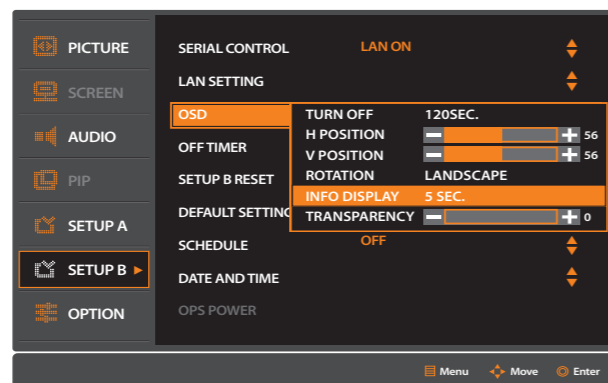

2. Setup the INFO DISPLAY.

- Press ▼ or ▲ buttons to select INFO OSD off time and press OK button.

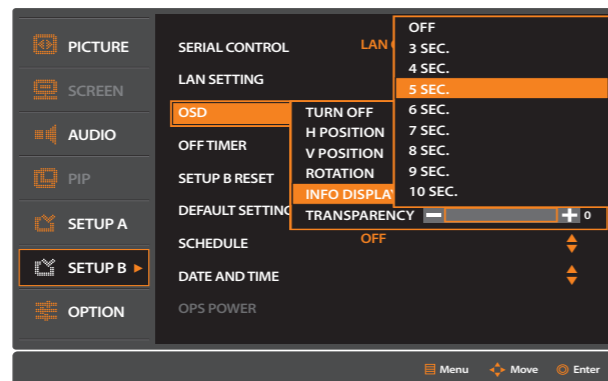

3. EXIT MENU

- Press Exit button to exit from the menu.

» TRANSPARENCY

- Setup the transparency level of the OSD.

1. Select TRANSPARENCY from OSD menu.

- Press ▼ or ▲ buttons to move to transparency and press OK button.

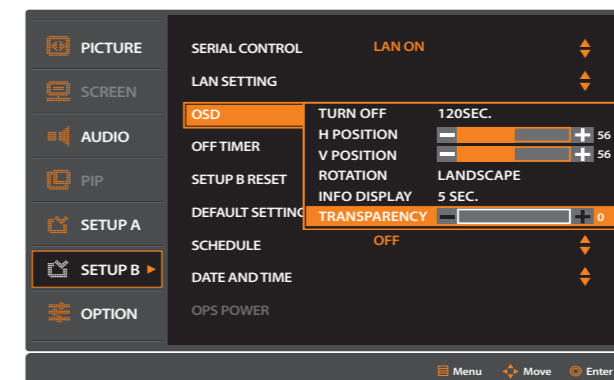

2. Setup the TRANSPARENCY.

- Press ◀ or ▶ buttons to adjust OSD TRANSPARENCY value and press OK button.

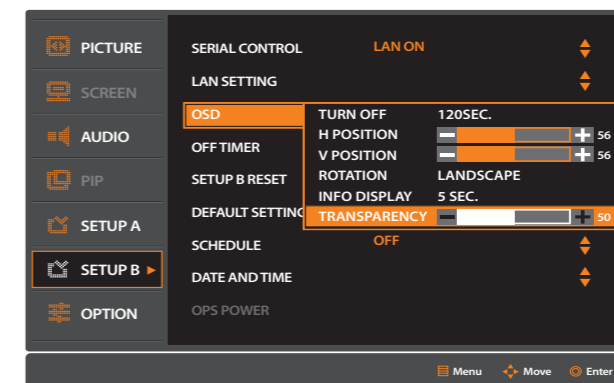

3. EXIT MENU

- Press Exit button to exit from the menu.

▶ OFF TIMER

- Setup the monitor to power off after a certain of time.
Time period can be selected from 1 to 24 hours.

1. Select OFF TIMER from SETUP B menu.

- Press ▼ or ▲ buttons to move to OFF TIMER and press OK button.

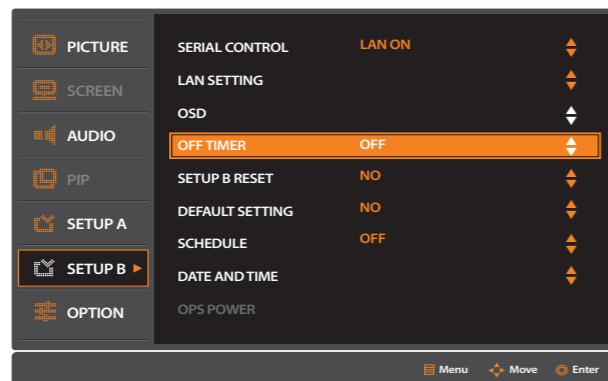

2. Setup the OFF TIMER.

- Press ▼ or ▲ buttons to select Power Off Time and press OK button.

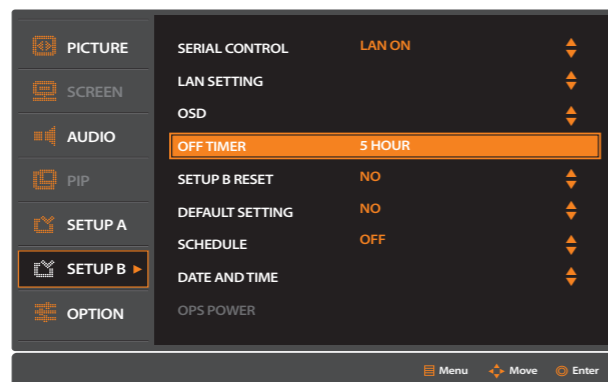

3. EXIT MENU

- Press Exit button to exit from the menu.

▶ SETUP B RESET

- Initialize the previously adjusted values of SCREEN B MENU.

1. Select SETUP B RESET from SETUP B menu.

- Press MENU button to display OSD.
- Press ▼ or ▲ buttons to move to SETUP B RESET and press MENU button.

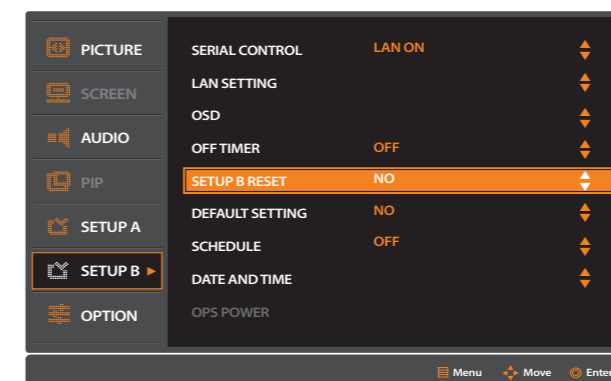

2. Initialize the previously adjusted values.

- Select YES or NO for initializing SETUP B menu.
- Press ▼ or ▲ buttons to move to YES and press MENU button to initialize the value.

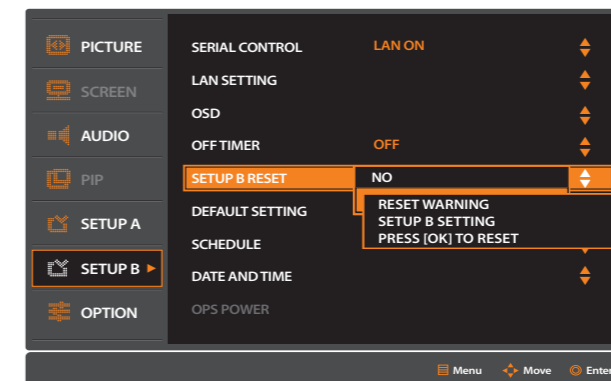

3. EXIT MENU

- Press Exit button to exit from the menu.

▶ DEFAULT SETTING

- Initialize the values of ALL OSD Setting .

1. Select DEFAULT SETTING from SETUP B menu.

- Press MENU button to display OSD.
- Press ▼ or ▲ buttons to move to DEFAULT SETTING and press MENU button.

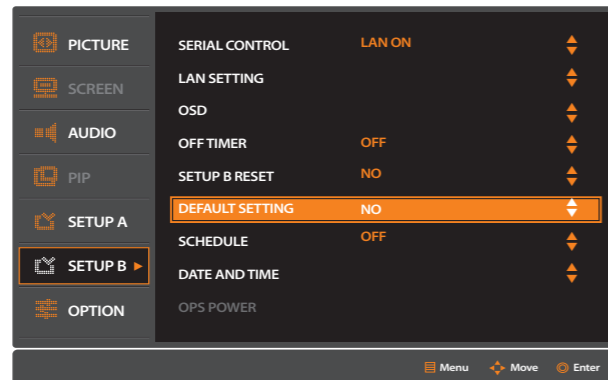

2. Initialize the previously adjusted values.

- Select YES or NO for initializing DEFAULT SETTING menu.
- Press ▼ or ▲ buttons to move to YES and press MENU button to initialize the value.

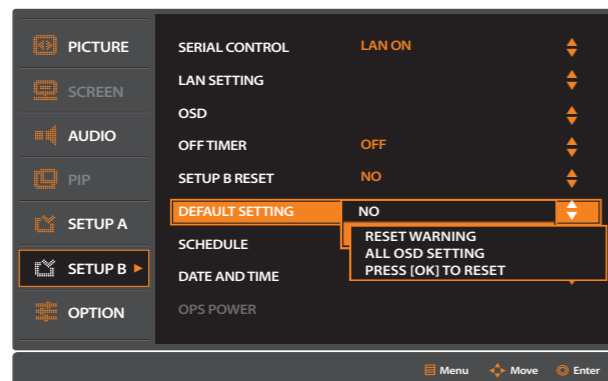

3. EXIT MENU

- Press Exit button to exit from the menu.

▶ SCHEDULE

- Configuration that users can choose is displayed repeatedly.

1. Select SCHEDULE from SETUP B menu.

- Press MENU button to display OSD.
- Press ▼ or ▲ buttons to move to SCHEDULE and press MENU button.

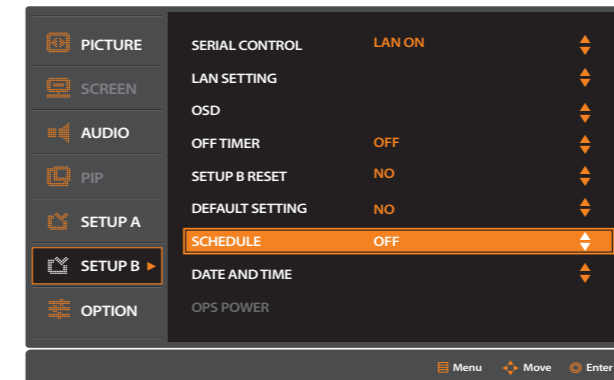

2. Setup the SCHEDULE.

- Select ON or OFF for SCHEDULE MODE menu.
- Press ▼ or ▲ buttons to move to adjust display on/off schedule.

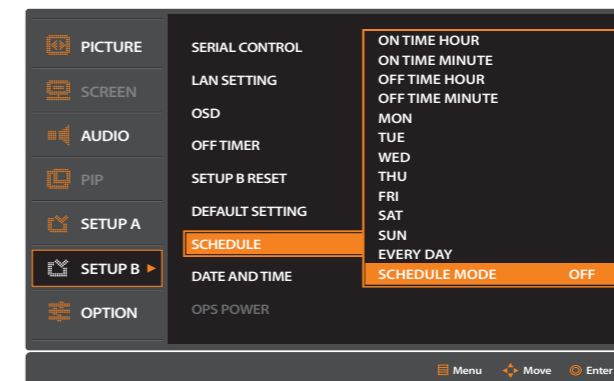

3. EXIT MENU

- Press Exit button to exit from the menu.

▶ DATE AND TIME

• Setup Date and Time.

1. Select DATE AND TIME from SETUP B menu.

- Press MENU button to display OSD.
- Press ▼ or ▲ buttons to move to DATE AND TIME and press MENU button.

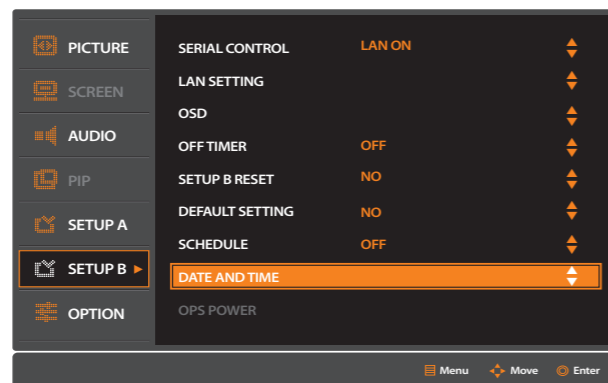

2. Setup DATE AND TIME.

- Select YES or NO for initializing DATE AND TIME menu.
- adjust date and time and select APPLY Menu to save the value.

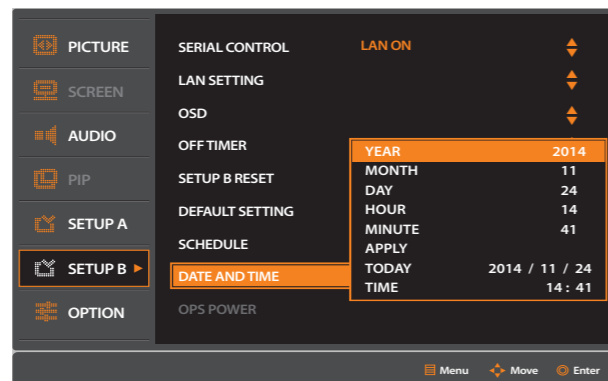

3. EXIT MENU

- Press Exit button to exit from the menu.

■ OPTION

• INPUT RESOLUTION, SCAN MODE, CHANGE SECURITY PASSWORD, TILING MENU LOCK, GROUP ID, IR CONTROL, TILING, LOOP OUT EQ, POWER ON DELAY and POWER ON INPUT DETECT can be adjusted in OPTION MENU.

1. Press MENU button.

- Press MENU button to display OSD MENU on the screen.

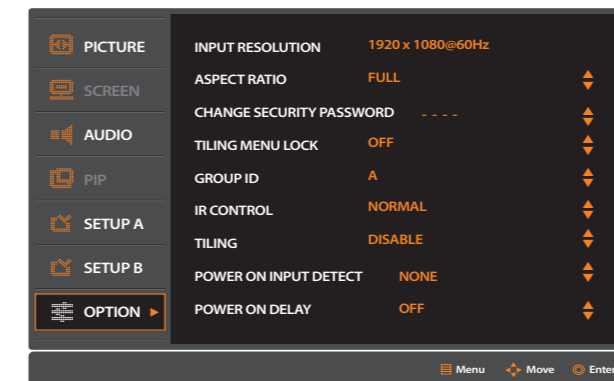

2. Select OPTION MENU.

- Press ▼ or ▲ buttons to move to OPTION MENU.
- When OPTION item is selected, press OK button to move to the SETUP A menu.

3. Select the sub-menu.

- Press ▼ or ▲ buttons to move to sub-menu.
- When sub-menu item is selected, press OK button to adjust the sub-menu.

4. Adjust the value.

- Each of the value can be adjusted by pressing ▼▲ buttons.

5. Exit from the MENU

- Press EXIT button to getting out of OSD MENU.

6. Move to Main MENU

- Press MENU button to move the Main Menu.



▶ INPUT RESOLUTION

- Display the current input resolution.

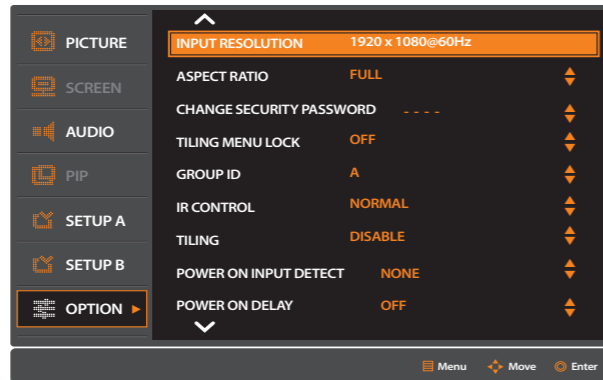

▶ ASPECT RATIO

- Some video formats may require different scanning modes in order to display best the image.

1. Select ASPECT RATIO from OPTION menu.

- Press ▼ or ▲ buttons to move to ASPECT RATIO and press OK button.

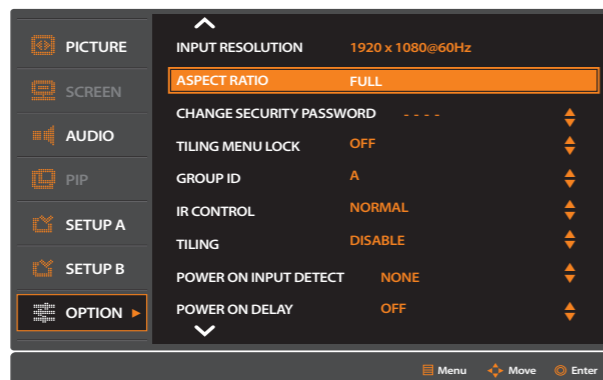

2. Select the desired ASPECT RATIO.

- Press ▼ or ▲ buttons to select Screen format and press OK button.

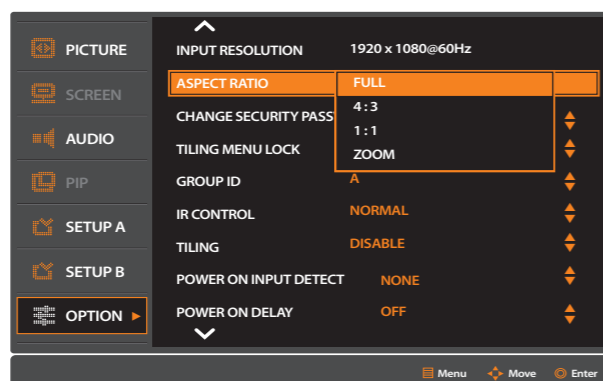

3. EXIT MENU

- Press Exit button to exit from the menu.

▶ CHANGE SECURITY PASSWORD

- Change the the security password. The factory preset password is 9999. This password is applied to the TILING MENU LOCK menu.

1. Select CHANGE SECURITY PASSWORD from OPTION menu.

- Press ▼ or ▲ buttons to move to CHANGE SECURITY PASSWORD and press OK button.

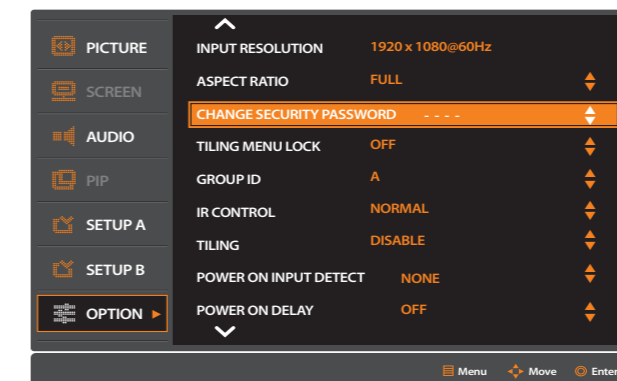

2. Change the SECURITY PASSWORD.

- Press ▼ or ▲ buttons to move to current and press OK button. Enter the password. (Default :9999)
- Press ▼ or ▲ buttons to move to new and press OK button. Enter the new password.
- Press ▼ or ▲ buttons to move to confirm and press OK button. Enter the new password to confirm.

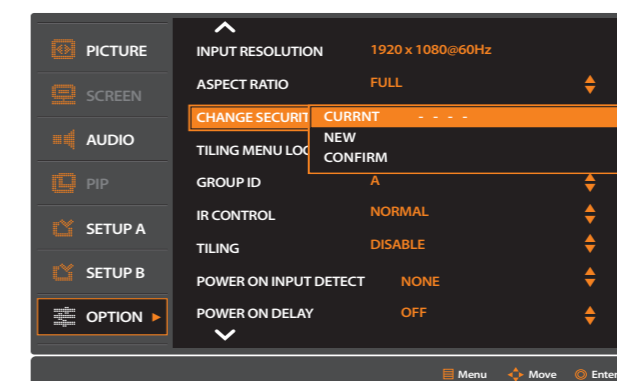

3. EXIT MENU

- Press Exit button to exit from the menu.

▶ TILING MENU LOCK

- Lock the tiling menu to protect the tiling display setting.

1. Select TILING MENU LOCK from OPTION menu.

- Press ▼ or ▲ buttons to move to TILING MENU LOCK menu and press OK button.

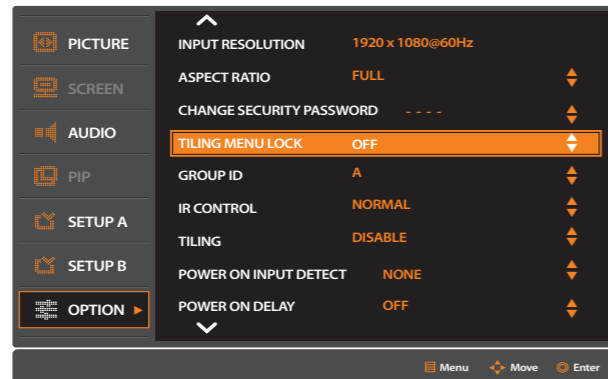

2. Setup the TILING MENU LOCK.

- Press ▼ or ▲ buttons to select ON or OFF and press OK button.

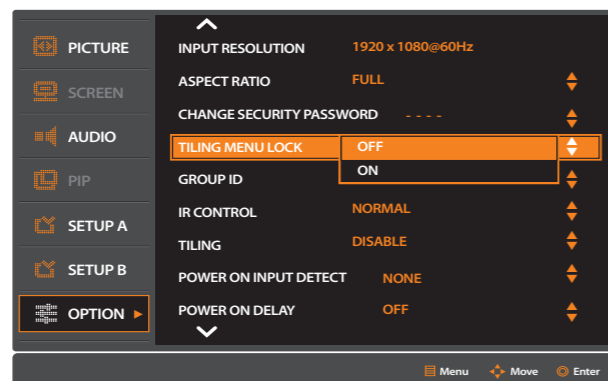

3. EXIT MENU

- Press Exit button to exit from the menu.

▶ GROUP ID

- Setup the Tiling Group.

1. Select GROUP ID from OPTION menu.

- Press ▼ or ▲ buttons to move to GROPU ID menu and press OK button.

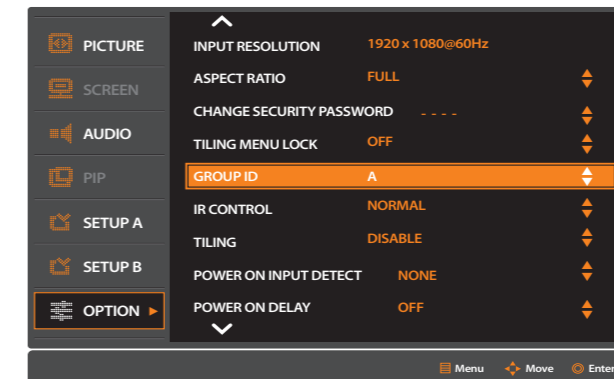

2. Select the GROUP ID.

- Press ▼ or ▲ buttons to select a group from group A to group J and press OK button.

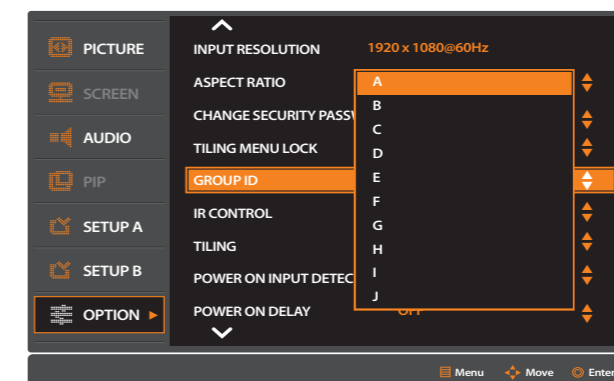

3. EXIT MENU

- Press Exit button to exit from the menu.

▶ IR CONTROL

- Prevents the monitor from being controlled by the remote controller.
To return to normal operation, or press the "ENT" button on the KEY PAD for 3 sec or press the "OPTION 1" button on the IR remote controller for 3sec.

1. Select IR CONTROL from OPTION menu.

- Press ▼ or ▲ buttons to move to IR CONTROL menu and press OK button.

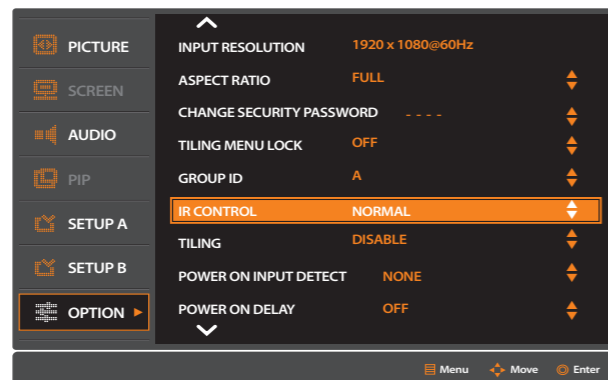

2. Select the IR CONTROL.

- Press ▼ or ▲ buttons to select NORMAL or LOCK and press OK button.

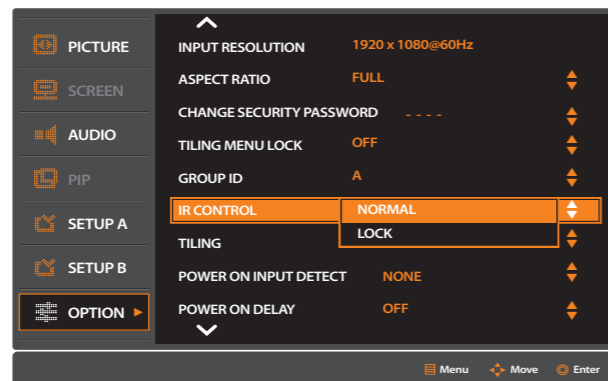

3. EXIT MENU

- Press Exit button to exit from the menu.

▶ TILING

- Allows one image to be expanded and displayed over multiple screens.

1. Select TILING from OPTION menu.

- Press ▼ or ▲ buttons to move to TILING menu and press OK button.

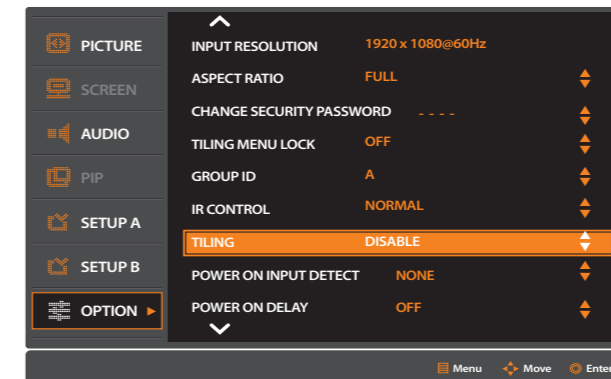

2. Setup the Tiling.

- Press ▼ or ▲ buttons to select ENABLE and press OK button.
- Press ▼ or ▲ buttons to select ON and press OK button.
- Press ▼ or ▲ buttons to select H Monitors and press OK button.
- Press ▼ or ▲ buttons to select the number of Horizontal Monitors and press OK button.
- Press ▼ or ▲ buttons to select V Monitors and press OK button.
- Press ▼ or ▲ buttons to select the number of Vertical Monitors and press OK button.
- Press ▼ or ▲ buttons to select Monitor ID and press OK button.
- Press ▼ or ▲ buttons to select the ID for each monitor and press OK button.
- Press ▼ or ▲ buttons to select FRAME COMP and press OK button.
- Press ▼ or ▲ buttons to select ON and press OK button.

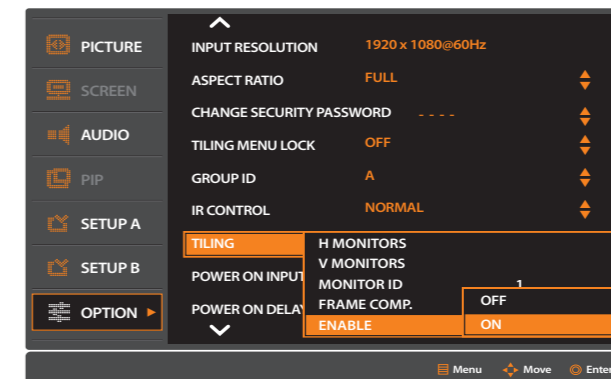

3. EXIT MENU

- Press Exit button to exit from the menu.

▶ POWER ON INPUT DETECT

- Select the default input source for power on.

1. Select POWER ON INPUT DETECT from OPTION menu.

- Press ▼ or ▲ buttons to move to POWER ON DETECT menu and press OK button.

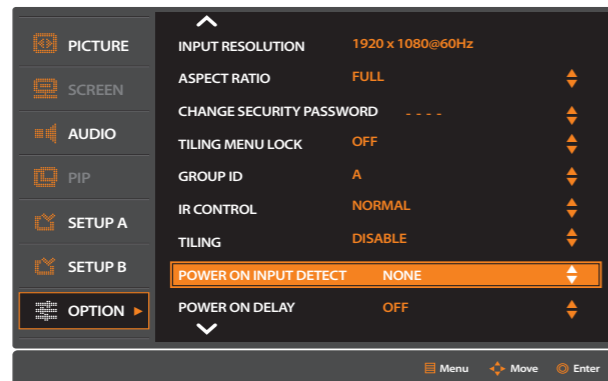

2. Select POWER ON INPUT DETECT.

- Press ▼ or ▲ buttons to setup input source and press OK button.

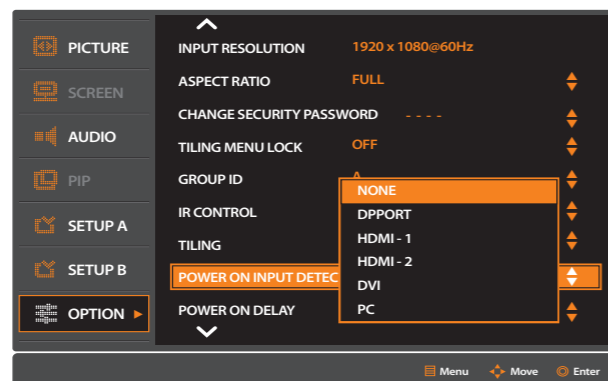

3. EXIT MENU

- Press Exit button to exit from the menu.

▶ POWER ON DELAY

- Adjust the delay time between being in “standby” mode and entering “power on” mode.

1. Select POWER ON DELAY from OPTION menu.

- Press ▼ or ▲ buttons to move to POWER ON DELAY menu and press OK button.

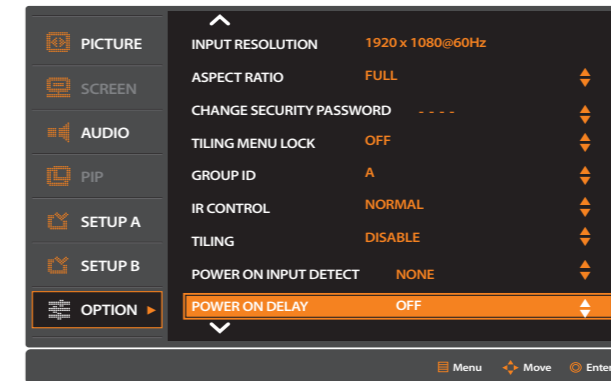

2. Setup POWER ON DELAY.

- Press ▼ or ▲ buttons to setup delay time and press OK button.(Off, 50ms.~2sec.)

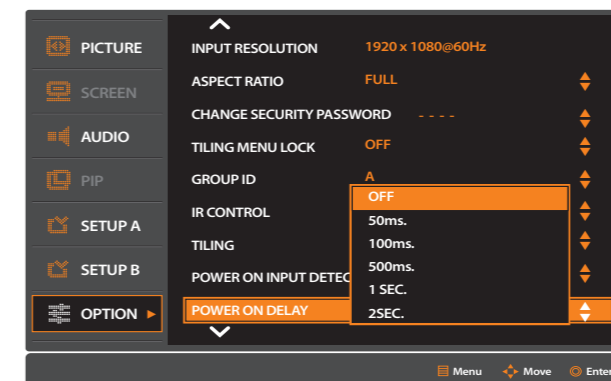

3. EXIT MENU

- Press Exit button to exit from the menu.

▶ SCREEN SAVER

- Select Screen Saver On / Off.

1. Select SCREEN SAVER from OPTION menu.

- Press ▼ or ▲ buttons to move to SCREEN SAVER menu and press OK button.

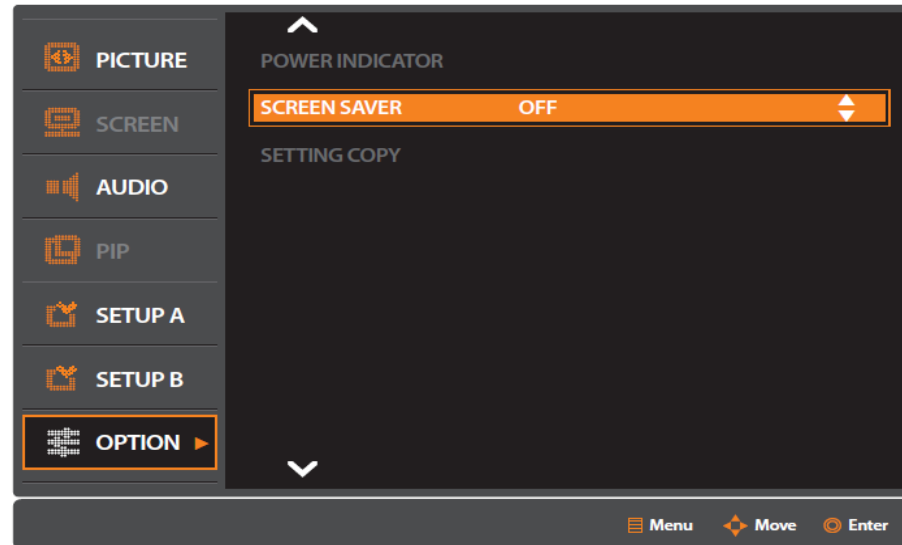

2. Setup SCREEN SAVER.

- Press ▼ or ▲ buttons to select ON or OFF and press OK button.

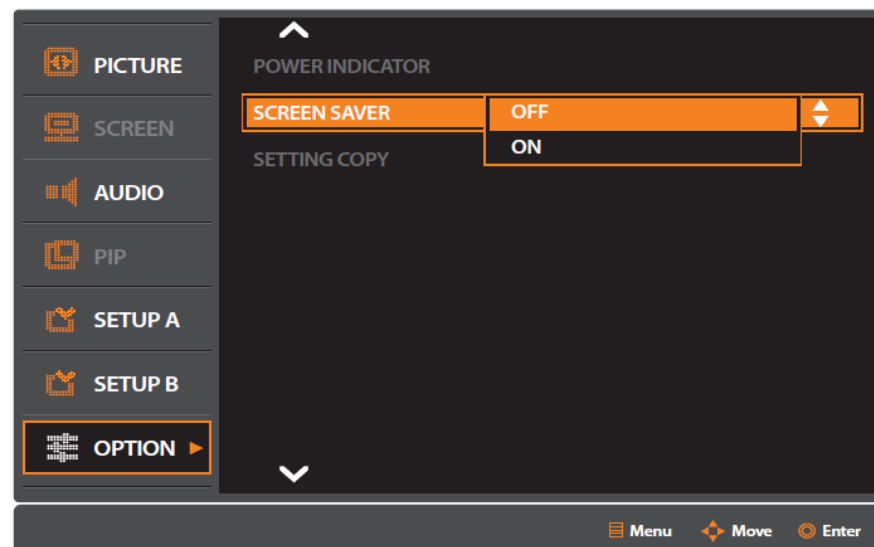

3. EXIT MENU

- Press Exit button to exit from the menu.

7. Before calling for service

- Before calling for any repair, check the following and then refer to a near A/S center.

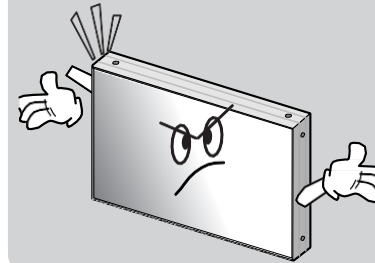

▶ "Tick" sound from the main body.

- If there is no problem with the screen or sound, the "tick" sound is likely to result from the cabinet lightly shrinking with the change of room temperature. The sound does not affect product's performance.

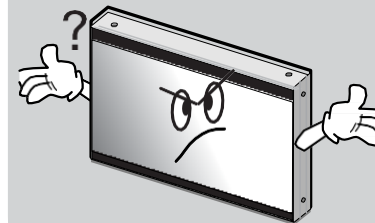

▶ No image at upper and lower part of the screen.

- As for a screen which is over 16:9 in width (such as cinema-sized one), no image may be displayed at upper and bottom part of the screen.

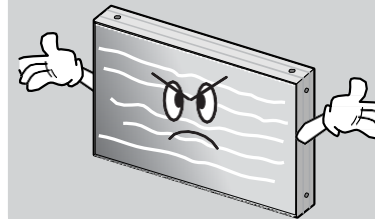

▶ Speckles or white lines on the screen

- Check whether the problem is caused by vehicle, streetcar, high-voltage cable or neon sign, which emitting interference wave or electromagnetic induction. Avoid any interfering object.

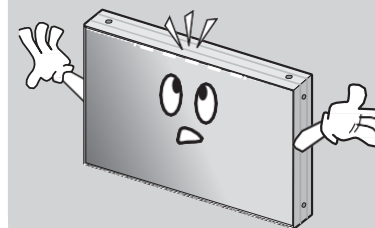

▶ Light leakage can be found at the edge areas around the screen.

- If the light leakage is not detected at 1m from the screen, the panel is considered as no defect. (LG LCD applies the same inspection standard)
- To minimize the light leakage, the monitor sets should be installed with high accuracy in horizontal and vertical position.

8. Applicable signals

Resolution	Pixel Clock [Mhz]	Horizontal [Pixels]				Vertical [Lines]				Pol. (H/V)	Standard Type	Input	
		Total	Addr. Width	Sync. Width	Back Porch	Total	Addr. Width	Sync. Width	Back Porch				
640*480*60	25.175	800	640	96	40	525	480	2	25	- / -	DMT	DP, HDMI, DVI, PC	
800*600*60	40.000	1054	800	128	88	628	600	4	23	+ / +	DMT		
1024*576*60	46.500	1296	1024	96	136	599	576	5	15	+ / +	VESA		
1024*768*60	65.000	1344	1024	136	160	806	768	6	29	- / -	DMT		
1280*768*60	79.500	1664	1280	128	192	798	768	7	20	- / +	CVT		
1280*960*60	108.000	1800	1280	112	312	1000	960	3	36	+ / +	CVT		
1280*1024*60	108.000	1688	1280	112	248	1066	1024	3	38	+ / +	DMT		
1360*768*60	85.500	1792	1360	112	256	795	768	6	18	+ / +	DMT		
1400*1050*60	121.750	1864	1400	144	232	1089	1050	4	32	- / +	CVT		
1600*900*60	118.250	2112	1600	168	256	934	900	5	26	- / +	CVT		
1600*1200*60	162.000	2160	1600	192	304	1250	1200	3	46	+ / +	DMT		
1920*1080*60	148.500	2200	1920	88	148	1125	1080	5	36	- / -	DTV		
480p	27.000	858	720	62	62	525	480	6	30	+ / +	DTV		DP, HDMI, DVI
576p	27.000	864	720	64	68	625	576	5	39	+ / +	DTV		
720p50	74.250	1980	1280	80	220	750	720	5	20	+ / +	DTV		
720p60	74.250	1650	1280	80	220	750	720	5	20	+ / +	DTV		
1080i50	74.250	2640	1920	88	148	1125	1080	5	20	+ / +	DTV		
1080i60	74.250	2200	1920	88	148	1125	1080	10	30	+ / +	DTV		
1080p50	148.500	2640	1920	88	148	1125	1080	5	36	- / -	DTV		
1080p60	148.500	2200	1920	88	148	1125	1080	5	36	- / -	DTV		

- DTV signal(EDTV, HDTV) is not supported in PC Input.

9. Specification

Product Name		ENB Multi-LCD Monitor	
Model Name		OLME-5550S	OLME-5570S
LCD Panel	Manufacture	LG	
	Back Light Unit Type	Direct LED	
	Module Dimension(H x V. mm)	1211.4 x 682.2	
	Active Display Area(H x V. mm)	1209.6 x 680.4	
	Number of Pixels(H x V)	1920 x 1080 (16:9)	
	Pixel Pitch(mm)	0.630 x 0.630	
	Display Colors	1.07 Billion (10 bits)	
	Luminance of White(Typ. cd/m ²)	500	700
	Contrast ratio (Typ.)	1400 : 1	
	Bezel to Bezel(mm)	1.8	
	Surface Treatment	Hard coating(3H), Anti-glare treatment of the front polarizer (Haze 44%)	
	Life Time (Typ. Ta : 25 ± °C)	60,000Hrs	
Power Supply		AC100V ~ 240V ± 10% (50/60Hz)	
Power Consumption	Maximum(W)	230	285
	Typ.(W)	195	250
	Stand-By(W)	≤ 0.5	
Dimension (W x H x D mm)		1211.5 x 682.3 x 100.2	
VESA Mounting (H x V. mm)		600 x 400	
Weights(kg)		24.5 ± 0.5	
Orientation		Portrait / Landscape	
Input Signal	Support Resolution	VGA, SVGA, XGA, SXGA, UXGA 480p,576p,720p(50/60),1080i(50/60),1080p(50/60)	
	HDCP	Support	
	Frequency	H : 57.3 ~ 70 kHz, V : 60 Hz	
In/Output Terminal	Input	DP x 1, HDMI x 2, DVI x 1, PC x 1, RS-232C x 1, LAN x1, IR x 1	
	Output	DVI (For HDMI1, HDMI2 and DVI) x 1, RS-232C x 1	

※Product design and specification can be changed for quality improvement without prior notice.

10. Regulatory Information

Manufacturer's Name: ORION CO.,LTD.

Manufacturer's Address: 217, 1gongdan-ro, Gumi-si, Gyeongsangbuk-do, Korea
Declares that the products Model Numbers: OLMU-5520

Conforms with the provisions of:

Council Directive 2004/108/EC on Electromagnetic Compatibility;

EN55022:2010 Radiated and Conducted Emissions from IT Equipment

EN55024:2010 Immunity of IT Equipment

Including:	EN61000-4-2	Electrostatic Discharge
	EN61000-4-3	Radiated Immunity
	EN61000-4-4	Electrical Fast Transients
	EN61000-4-5	Line Surge
	EN61000-4-6	RF Conducted Susceptibility
	EN61000-4-8	Magnetic Field Immunity
	EN61000-4-11	Voltage Dips and Interrupts

And:	EN61000-3-2	Harmonic Current Emissions
	EN61000-3-3	Voltage fluctuations and Flicker

Council Directive 2006/95/EC on Low Voltage Equipment Safety:

EN60950:2006+A11+A1+A12 Safety of IT Equipment

Note: This equipment has been tested and found to comply with the limits for a Class A digital device, pursuant to part 15 of the FCC Rules. These limits are designed to provide reasonable protection against harmful interference when the equipment is operated in a commercial environment. This equipment generates, uses, and can radiate radio frequency energy and, if not installed and used in accordance with the instruction manual, may cause harmful interference to radio communications. Operation of this equipment in a residential area is likely to cause harmful interference in which case the user will be required to correct the interference at his own expense.

Any changes or modifications to the display not expressly approved by could void the user's authority to operate this equipment.

Other Certifications

CISPR 22

11. Dimension

▶ OLME-5550S / OLME-5570S

